

# Production Tools

INNOVACIÓN MODULAR PARA LA INDUSTRIA

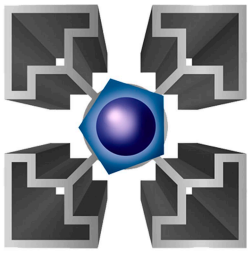





**Production Tools**

## ESPECIFICACIONES DE PERFILES

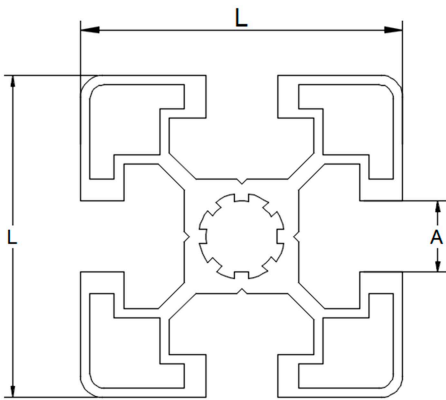
Con el sistema modular del perfil, ofrece de una solución rápida y eficaz para todas las tareas: estaciones de trabajo, líneas de ensamble, disposición de material, paneles informativos de ayuda visual, poka yoke y dispositivos adaptables a cualquier necesidad.



PERFIL	L(mm)	A(mm)	kg / m	SÍMB.
45	45	10	1.250	

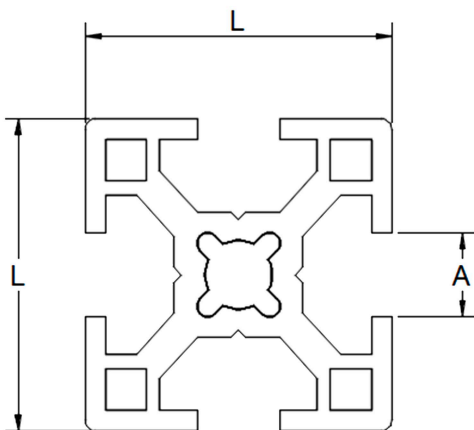

PERFIL	L(mm)	A(mm)	kg / m	SÍMB.
30	30	8	0.666	

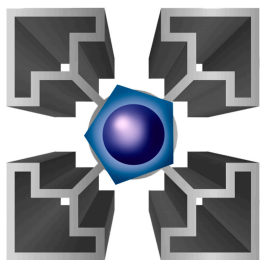

**Production Tools**

# ÍNDICE

## 01

### **CARROS DE ALMACENAMIENTO**

Carros porta gavetas.  
Carros porta tinas.

## 02

### **MESAS**

Estándar fijas.  
Fijas para taller.  
Estándar Móvil.  
Para taller móviles.

## 03

### **PIZARRONES Y PÁNELES MÚLTIPLES**

Fijos.  
Móviles.  
Pedestal.

## 04

### **RACKS**

Fijos.  
Móviles.  
Especiales Fijos.  
Especiales Móviles.  
Contenedores de almacenamiento.

## 05

### **CARROS**

Tipo Mesa.  
Tipo con charola.  
Tipo Repisa.  
Carros para herramienta.

## 06

### **TRANSPORTADORES Y DISPOSITIVOS**

Transportador  
Patines  
Dispositivos mecánicos.  
Dispositivos con accionamiento.

## 07

### **PLATAFORMAS Y ESCALERAS**

Escaleras.  
Plataformas.

## 08

### **GUARDAS**

Con maya.  
Cerradas.

## 09

### **CABINAS**

Cabinas de inspección.  
Sobre diseño.

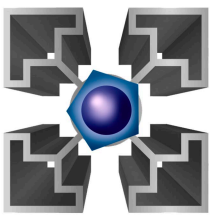

## Production Tools

### 100-110-001

Carro para disposición de materiales-  
cuatro niveles.

Incluye:

16 gavetas de 17x10.5x7.6 cm

6 gavetas de 18.5x11.8x7.6cm

4 gavetas de 27.6x16.2x12.5cm

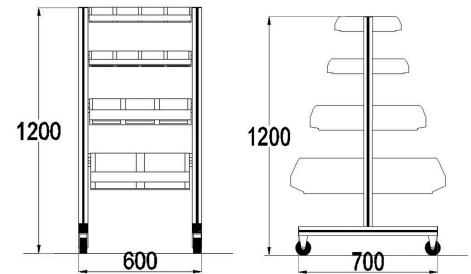
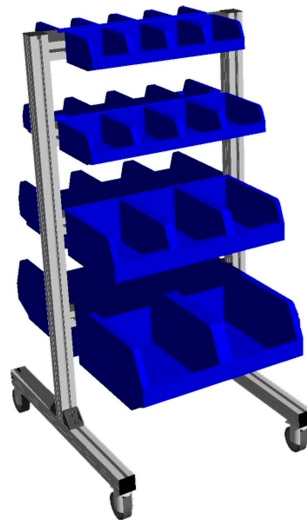

### 100-110-002

Carro para disposición de materiales  
cuatro niveles.

Incluye:

22 gavetas de 17x10.5x7.6

8 gavetas de 18.5x11.8x7.6

6 gavetas de 27.6x16.12

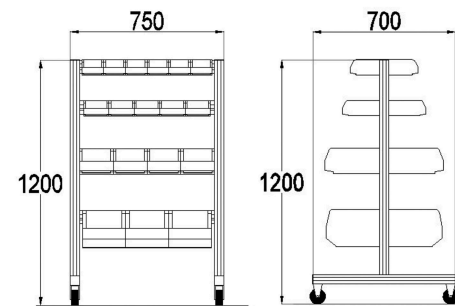

### 100-110-003

Carro para disposición de materiales  
cuatro niveles.

Incluye:

30 gavetas de 17x10.5x7.6cm

10 gavetas de 18.5x11.8x7.6cm

8 gavetas de 27.6x16.2x12.5

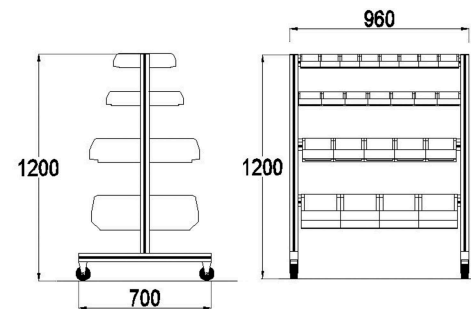
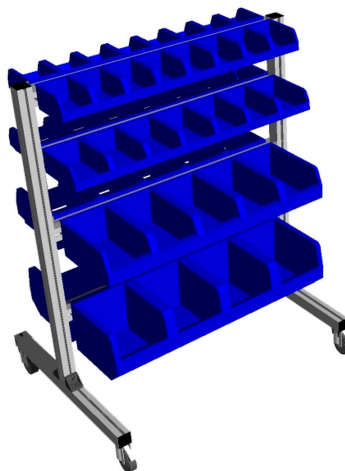

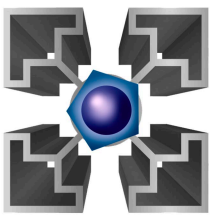

# CARROS PORTA GAVETAS O CONTENEDORES

## Production Tools

### 100-110-004

Carro alto para disposición de materiales cuatro niveles.

Incluye:

30 gavetas de 17x10.5x7.6 cm

15 gavetas de 18.5x11.8x7.6 cm

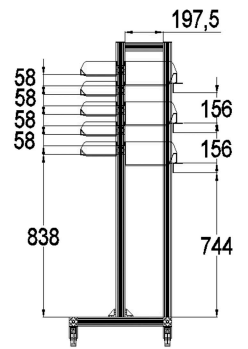
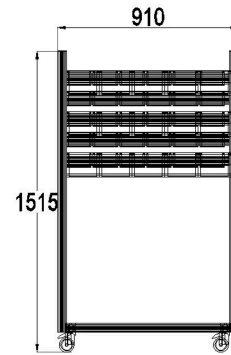
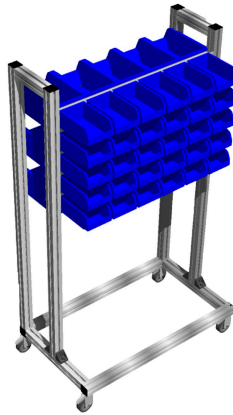

### 100-110-005

Carro para disposición de materiales, tres repisas ajustables.

Incluye:

2 tinas de 38.0x24.0x10.4

1 tina de 48.0x38x10.4

1 tina de 48.0x38x20

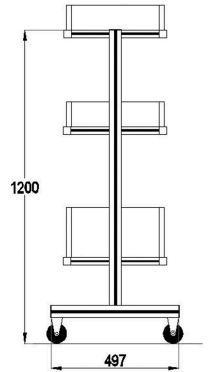
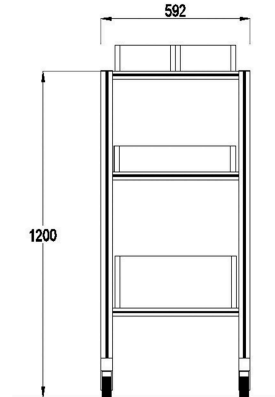
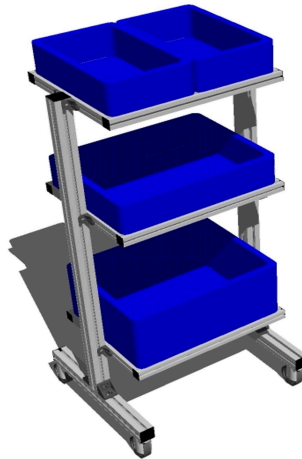

### 100-110-006

Carro para disposición de materiales de tres niveles.

Incluye:

16 tinas de 38.0x24.0x10.4

3 tinas de 48.0x38x20

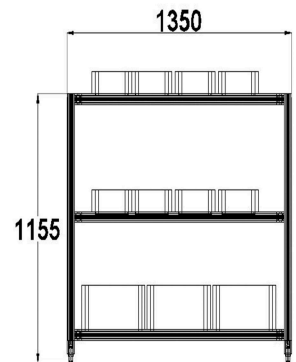
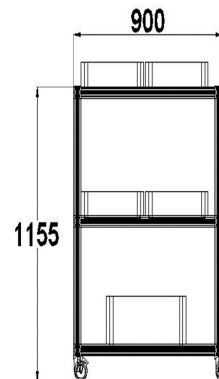
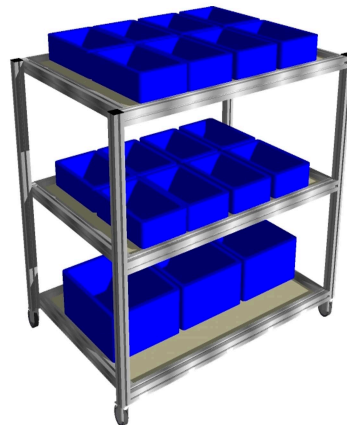

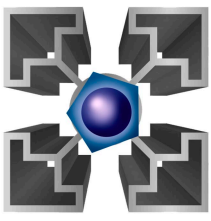

## Production Tools

### 100-110-007

Carro para disposición de materiales con cuatro niveles para gavetas y 2 niveles para tinas.

Incluye:

16 gavetas de 17 x 10.5 x 7.6 cm

1 tina de 38.0 x 24.0 x 10.4

1 tina de 48.0 x 38 x 20

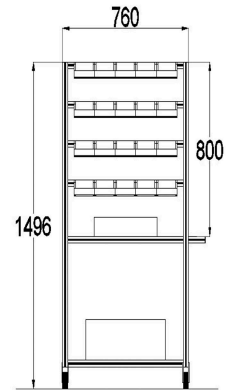
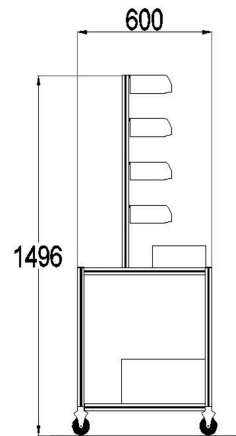
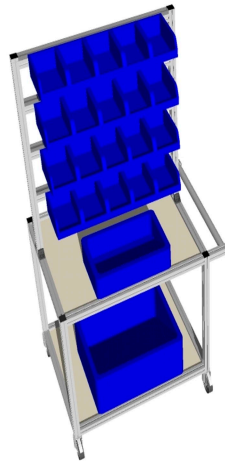

### 100-110-008

Carro de picking.

Incluye:

1 caja de 76.8.0x48x20

6 cajas de 48.0x38x20

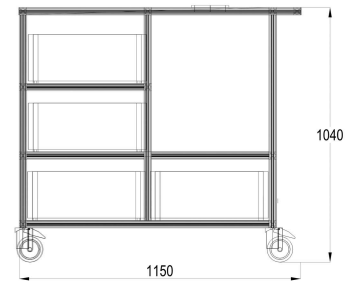
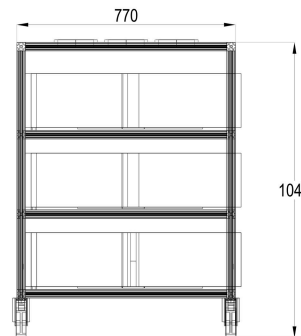

### 100-110-009

Carro picking con 7 niveles.

Incluye:

6 cajas de 75.8.0x48x20

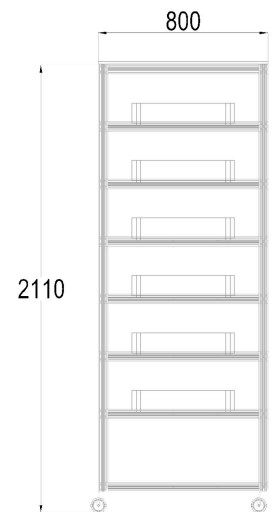
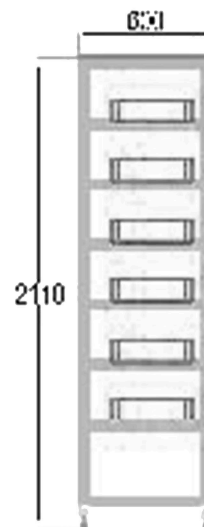
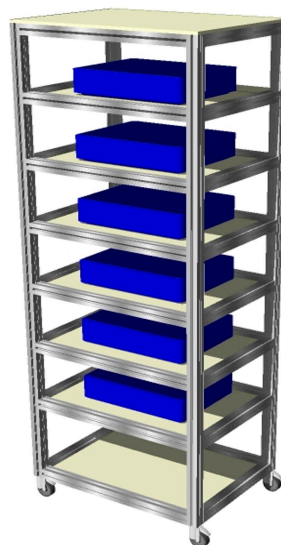

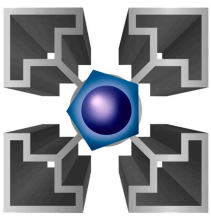

# CARROS PORTA GAVETAS O CONTENEDORES

## Production Tools

### 100-120-001

Dispensador de material de cinco niveles.

Incluye:

10 cajas de 38 x 24 x 10.5

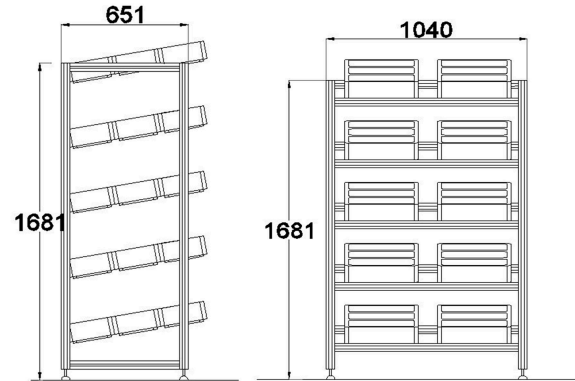
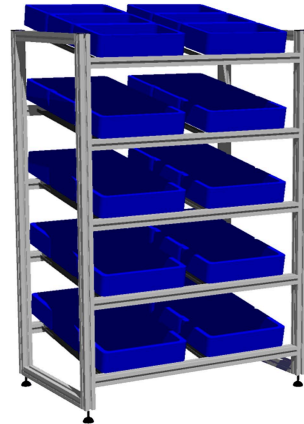

### 100-120-002

Separador de carga dos niveles de alimentación, capacidad de carga 15 kg por caja.

incluye:

4 cajas de 48 x 38 x 10.4

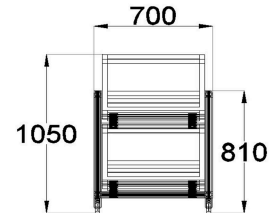
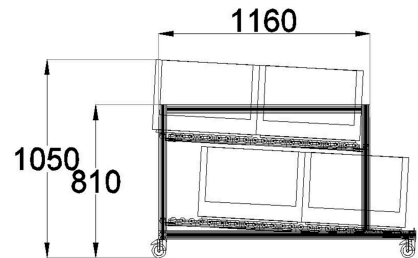

### 100-120-003

Separador de carga con dos niveles de alimentación y un nivel de retorno, capacidad de carga 15 kg por caja.

Incluye:

7 cajas de 48 x 38 x 10.4

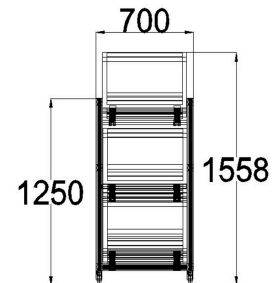
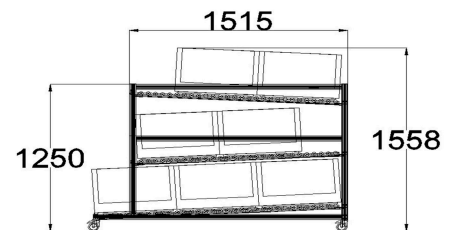
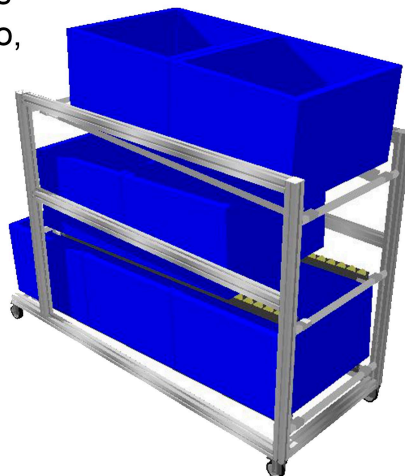

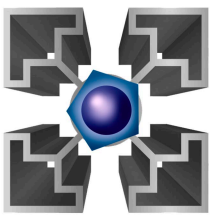

## Production Tools

### 100-120-004

Porta tinas con dos niveles de alimentación y uno de retorno.

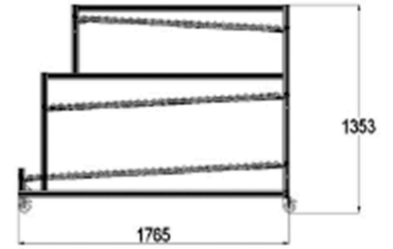

### 100-120-005

Porta tinas con dos niveles de alimentación y uno de retorno.  
(no incluye tinas)

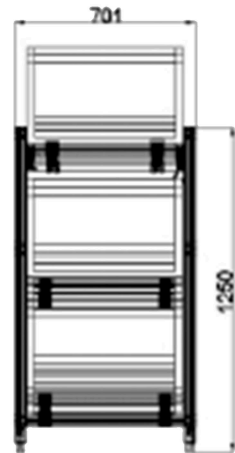
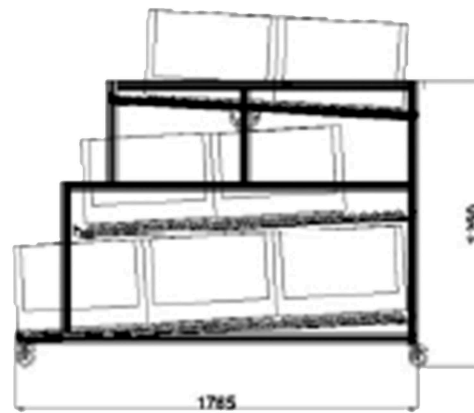
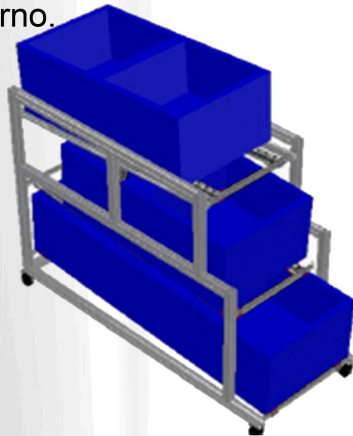

### 100-120-006

Porta gavetas con siete niveles de alimentación.

incluye:

98 gavetas de 17 x 10.5 x 7.6 cm

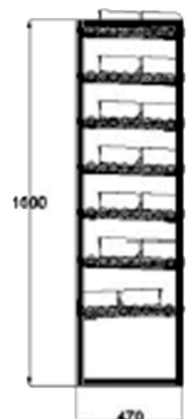
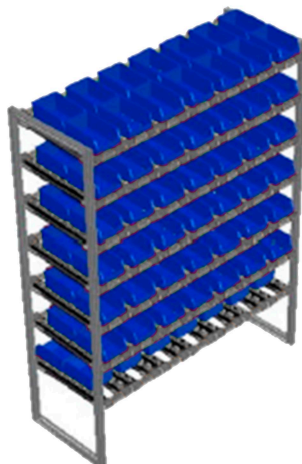



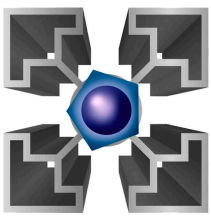

# CARROS PORTA GAVETAS O CONTENEDORES

## Production Tools

### 100-120-007

Porta tinas con un nivel doble de alimentación y un nivel doble de retorno (no incluye tinas).

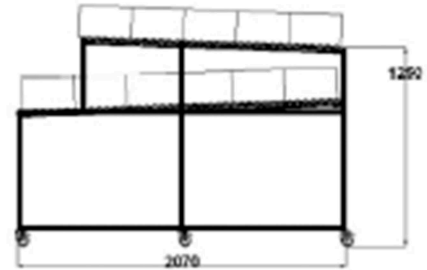
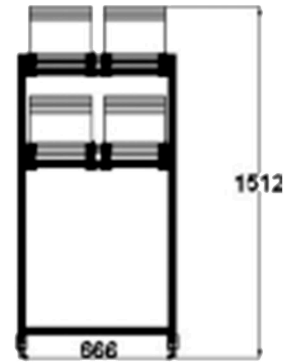
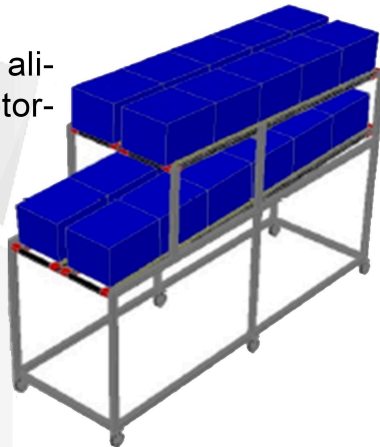

### 100-120-008

Porta tinas con dos niveles dobles de alimentación y un nivel doble de retorno (no incluye tinas).

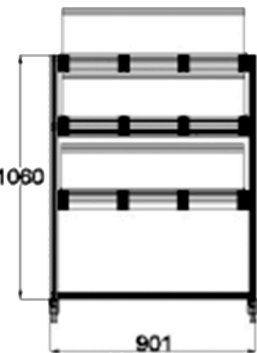
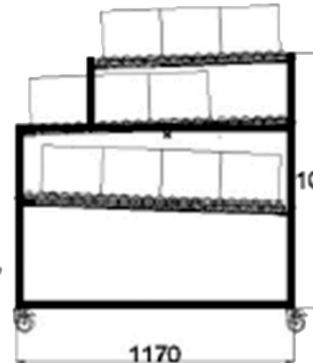
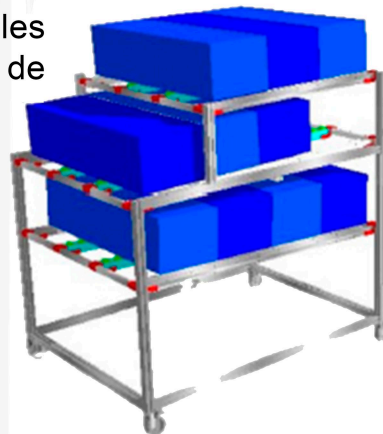

### 100-120-009

Porta tinas con dos niveles dobles de alimentación y un nivel doble de retorno (no incluye tinas).

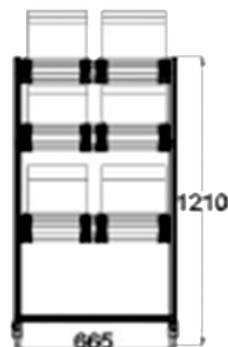
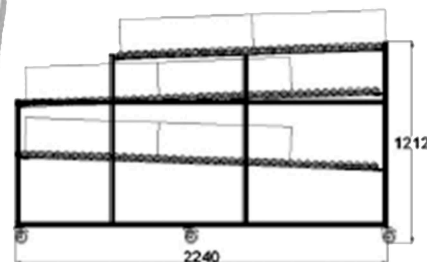
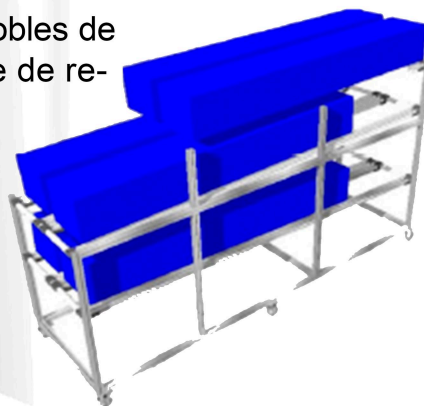

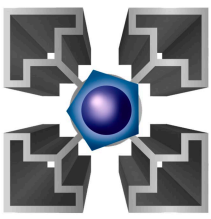

## Production Tools

### 100-120-010

Porta tinas con un nivel doble de alimentación y un nivel doble de retorno (no incluye tinas.)

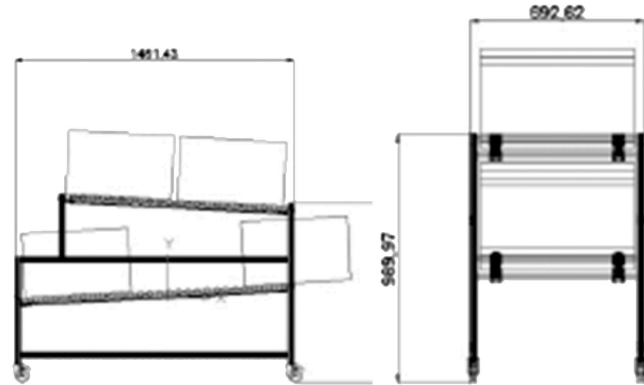
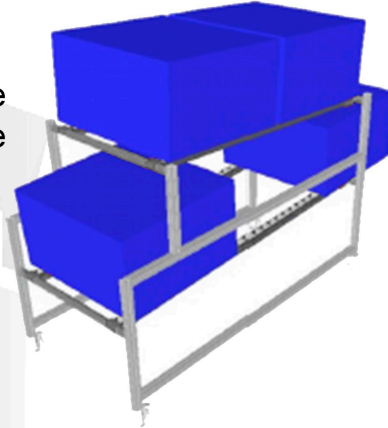

### 100-120-011

Porta tinas con dos niveles dobles de alimentación y un nivel doble de retorno (no incluye tinas.)

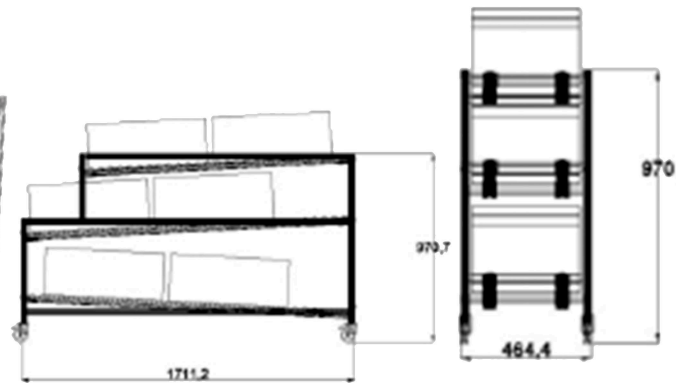
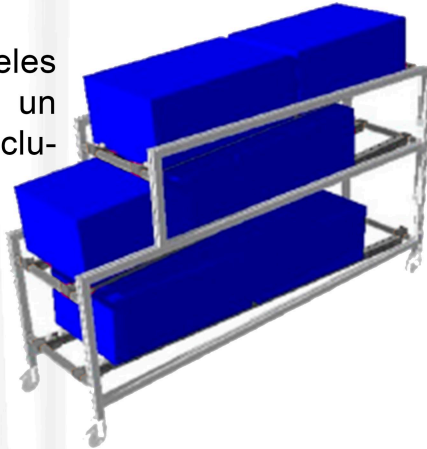

### 100-120-012

Porta tinas con tres niveles dobles de alimentación.(no incluye tinas.)

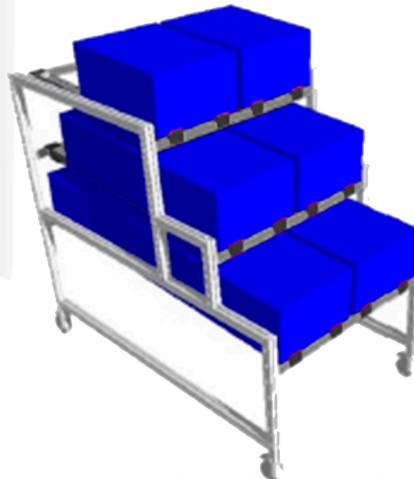

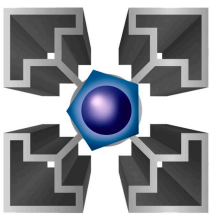

## Production Tools

### 100-120-013

Porta tinas largo con un nivel de alimentación y un nivel de retorno (no incluye tinas.)

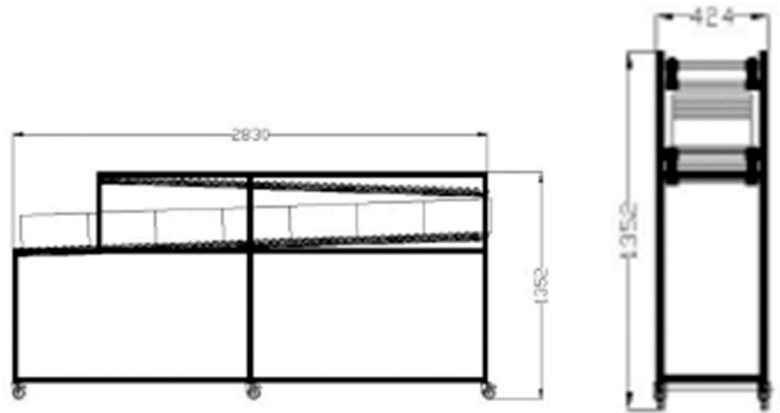
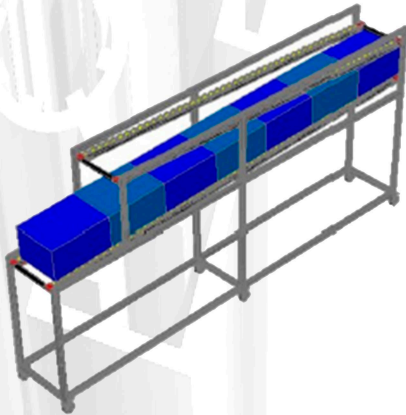

### 100-120-014

Porta tinas largo con un nivel de alimentación

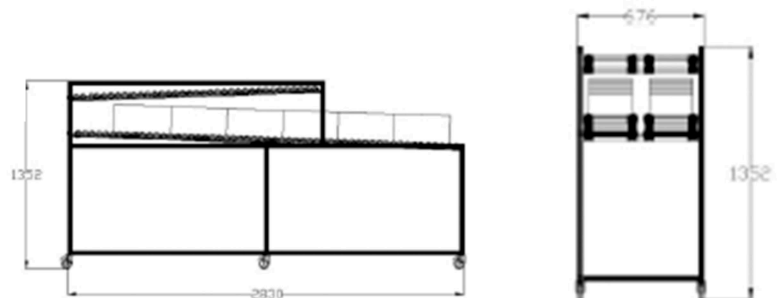
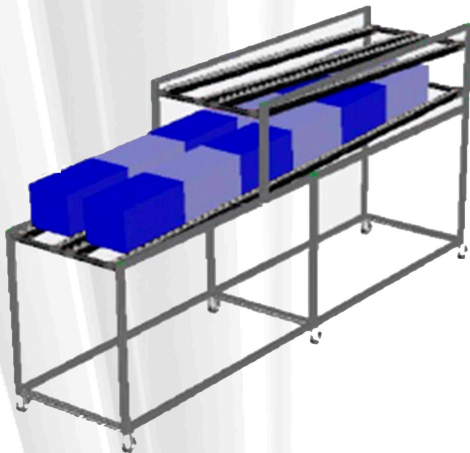

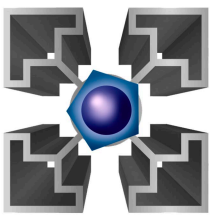

**Production Tools**

**100-210-001**

Mesa de trabajo corta de dos niveles con cubiertas de neopreno.

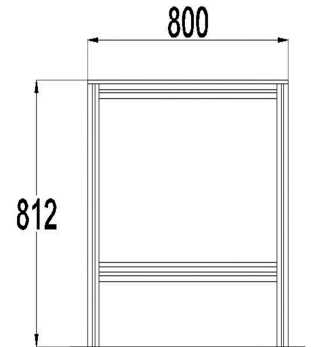
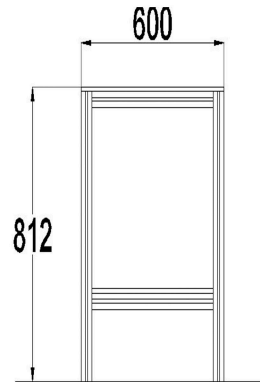
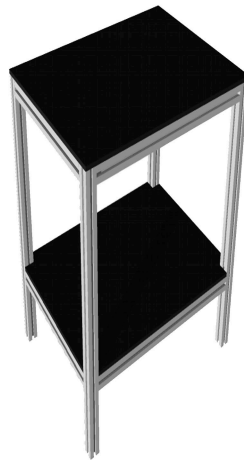

**100-210-002**

Mesa de trabajo larga con cubierta de neopreno.

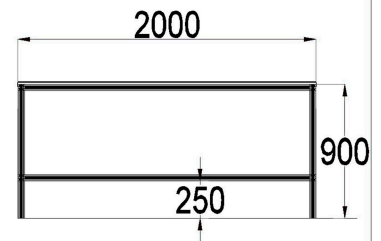
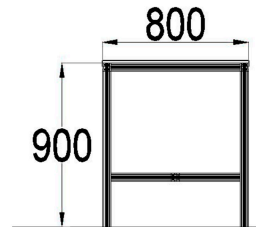

**100-210-003**

Mesa de computo.

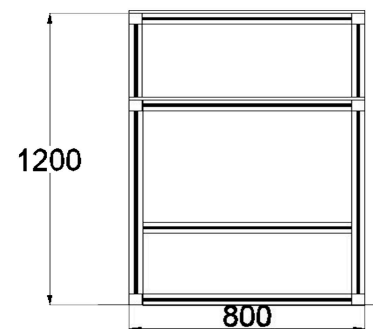
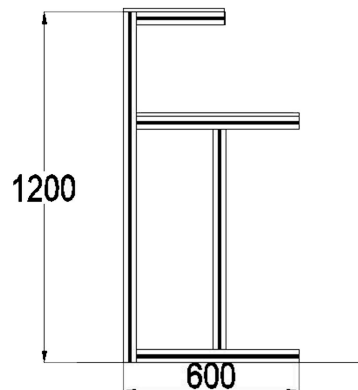
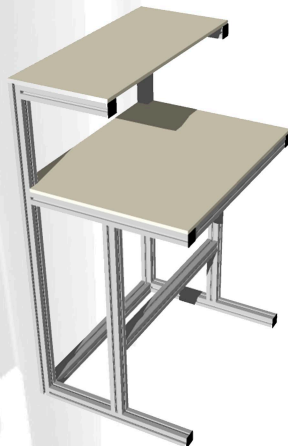

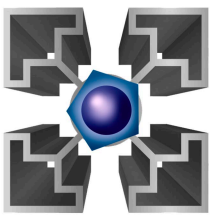

## Production Tools

### 100-210-004

Mesa de trabajo simple cubierta de melamina blanca.

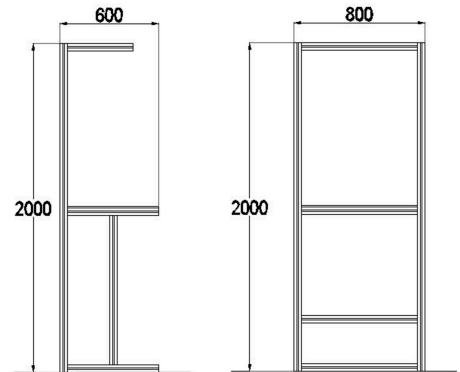

### 100-210-005

Escritorio esquinero con cubierta de neopreno y tapa de melamina en sus costados.

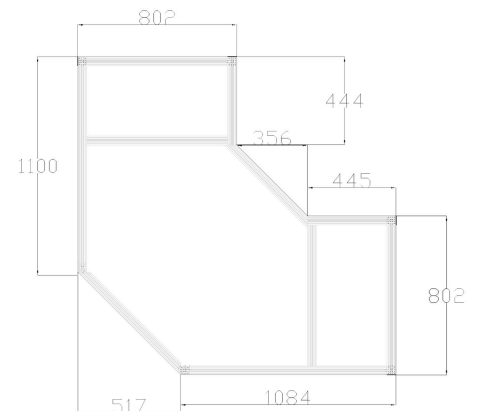
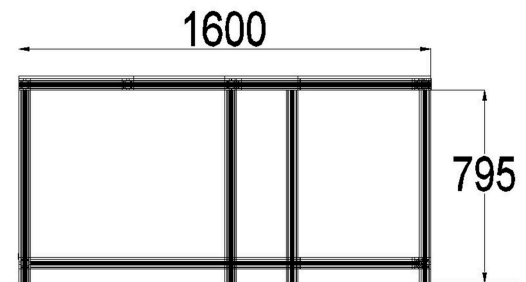
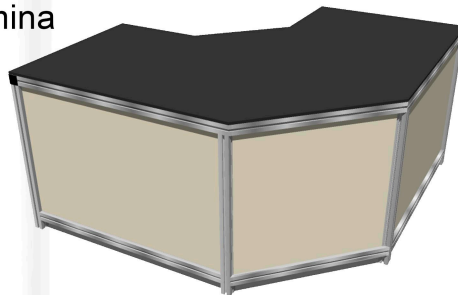

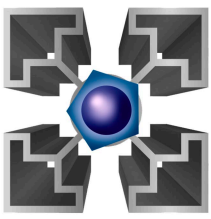

Production Tools

100-211-001

Mesa de trabajo simple.  
Incluye:  
12 gavetas de 17 x 10.5 x 7.6 cm

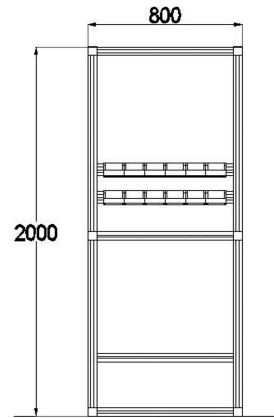
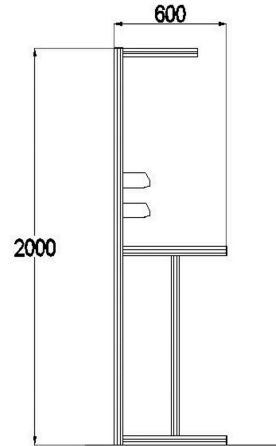
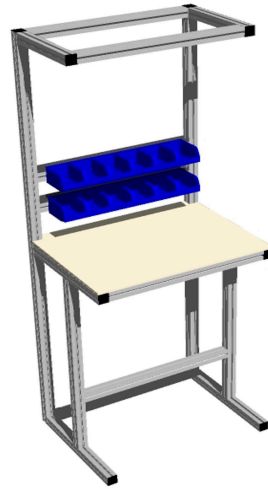

100-211-002

Mesa de trabajo con rodillos.  
Incluye:  
12 gavetas de 17 x 10.5 x 7.6 cm

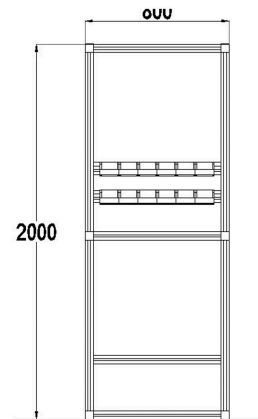
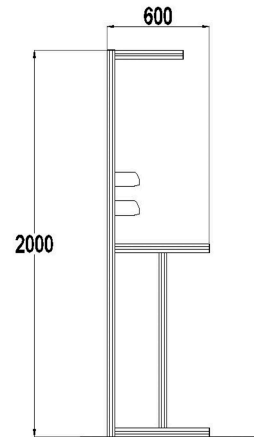
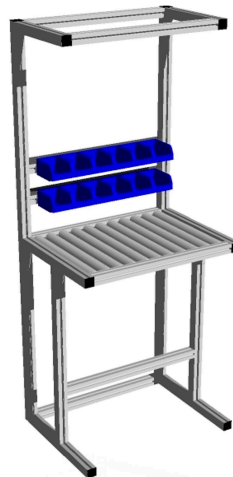

100-211-003

Mesa con inclinación, tres divisiones para alimentación.

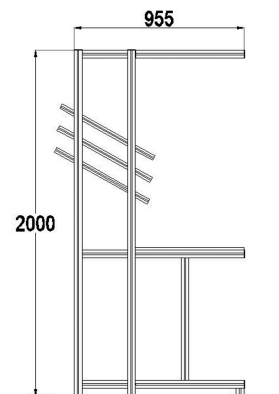
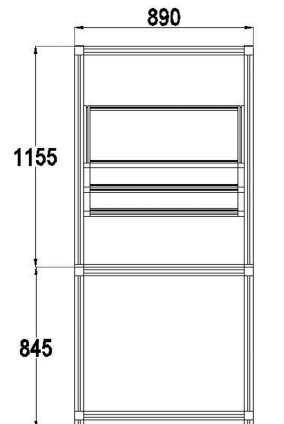
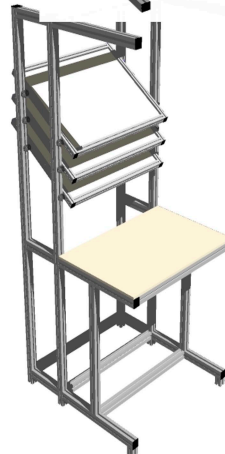

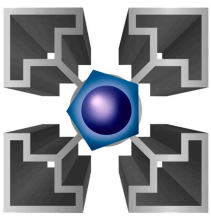

## Production Tools

### 100-211-004

Mesa de trabajo con cubierta de melamina.

Incluye:

1 cajón metálico

3 repisas metálicas, porta hojas.

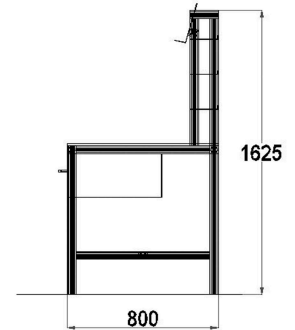
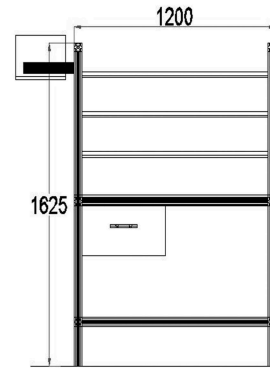

### 100-211-005

Mesa de trabajo con cubierta de neopreno.

Incluye:

3 cajones metálicos

3 repisas metálicas.

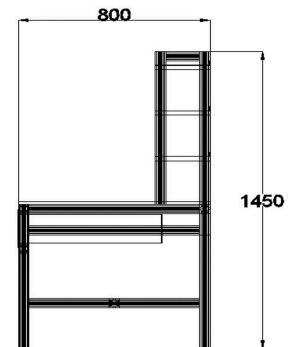
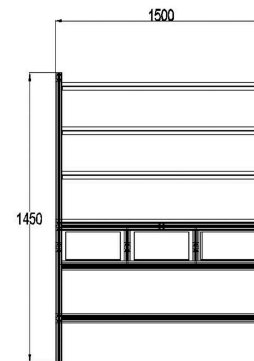

### 100-211-006

Mesa con bastidor superior cubierta de melamina, entrepaños y anaquel metálico.

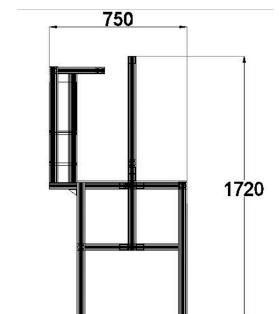
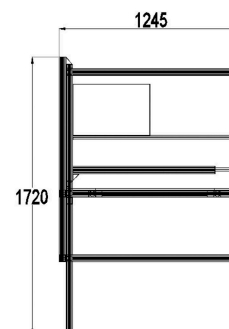

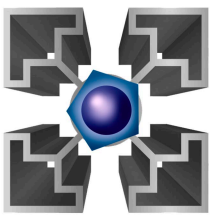

**Production Tools**

**100-220-001**

Mesa móvil de dos niveles en melamina blanca.

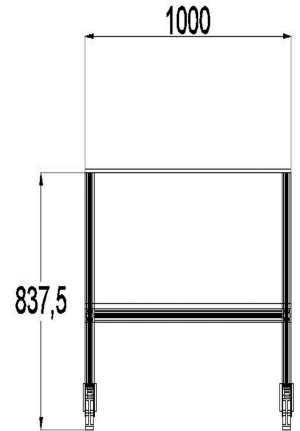
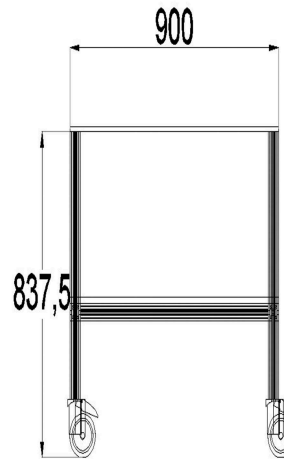

**100-220-002**

Mesa móvil de tres niveles en melamina blanca.

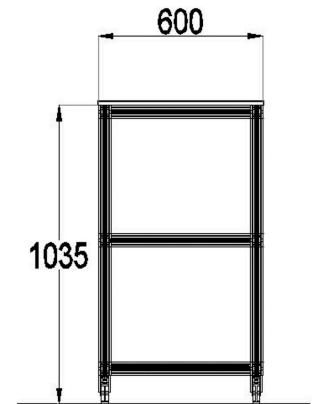
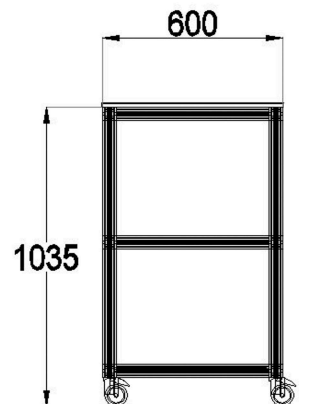
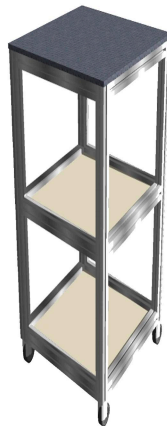

**100-220-003**

Carro para reparación con cubierta de neopreno, bastidor vertical.

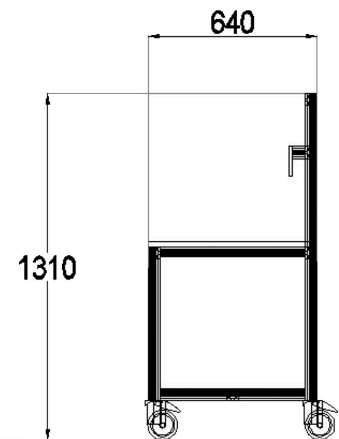
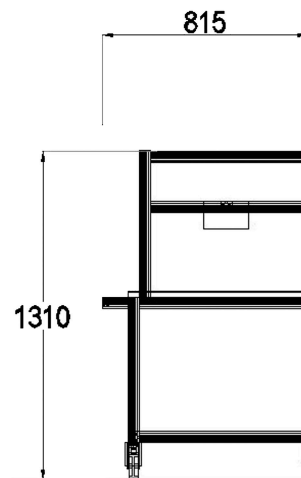



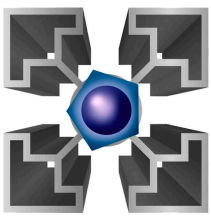

## Production Tools

### 100-230-001

Mesa móvil con repisa de extensión.

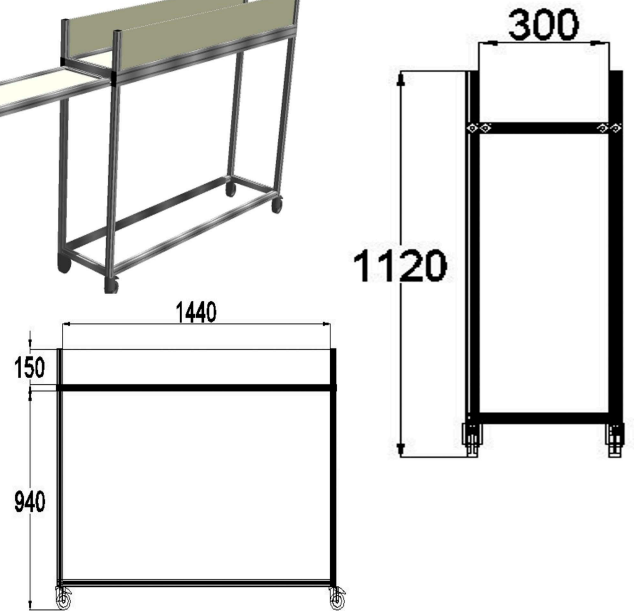
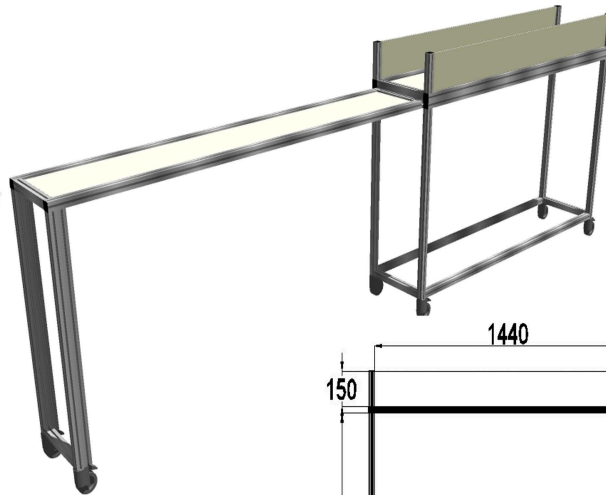

### 100-230-002

Carro de transporte de accesorios con 4 niveles de separadores.

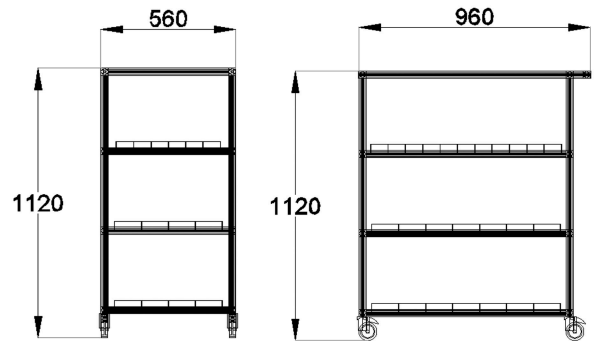

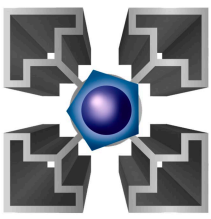

**Production Tools**

**100-240-001**

Carro de soporte.

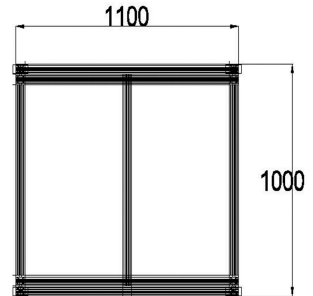
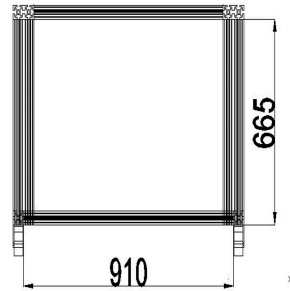

**100-240-002**

Carro de soporte con cubierta de naylamid.

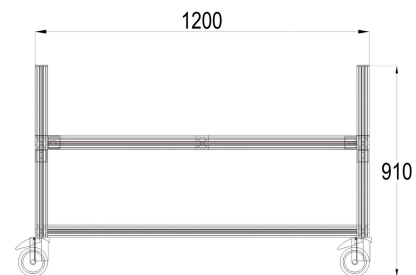
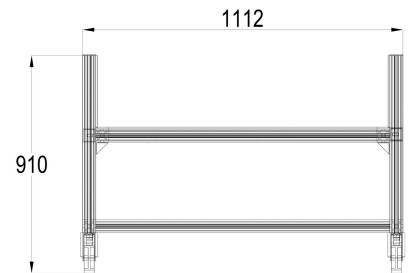

**100-240-003**

Soporte para trabajo pesado.

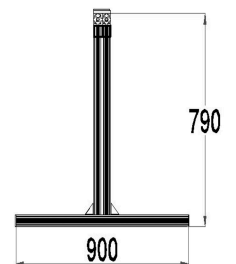
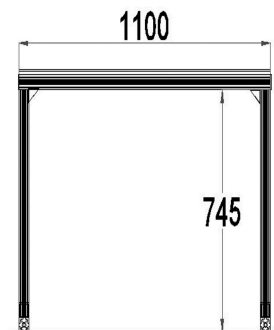

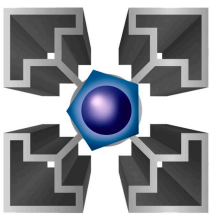

## Production Tools

### 100-240-001

Carro de soporte.

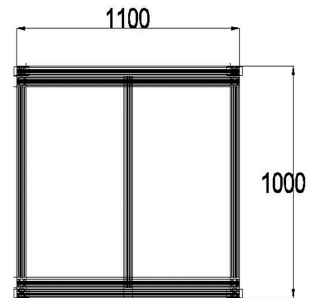
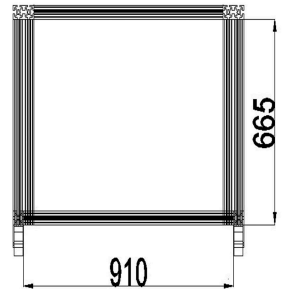

### 100-240-002

Carro de soporte con cubierta de naylamid.

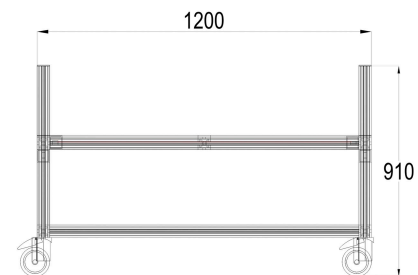
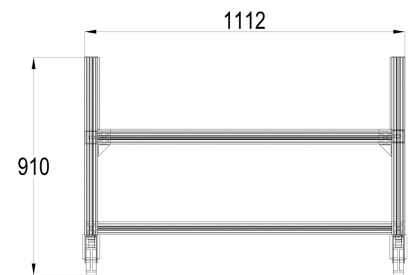

### 100-240-003

Soporte para trabajo pesado.

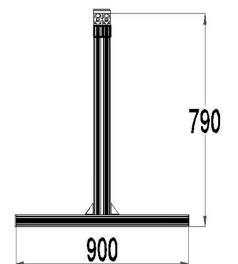
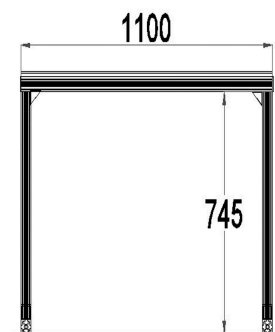

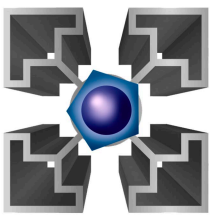

## Production Tools

### 100-310-001

Panel institucional.

Incluye:

6 Acrílicos verticales con encabezado.

4 Acrílicos doble carta con encabezado.

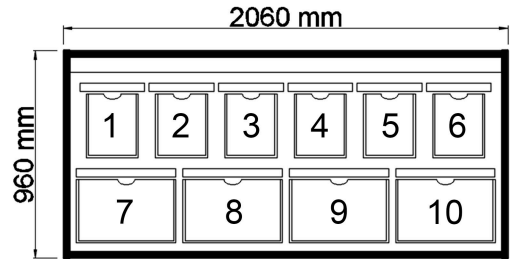
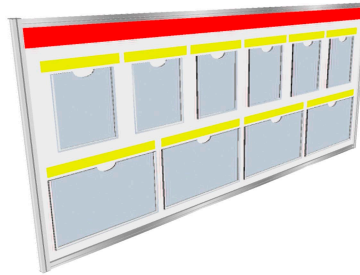

- 1: Misión
- 2: Visión
- 3: Política
- 4: Valores
- 5: Objetivo
- 6: Filosofía
- 7: Días sin accidentes
- 8: Varios
- 9: Varios
- 10: Varios

### 100-310-002

Panel de línea de producción.

Incluye:

2 Acrílicos verticales con encabezado.

1 Acrílicos doble carta con encabezado.

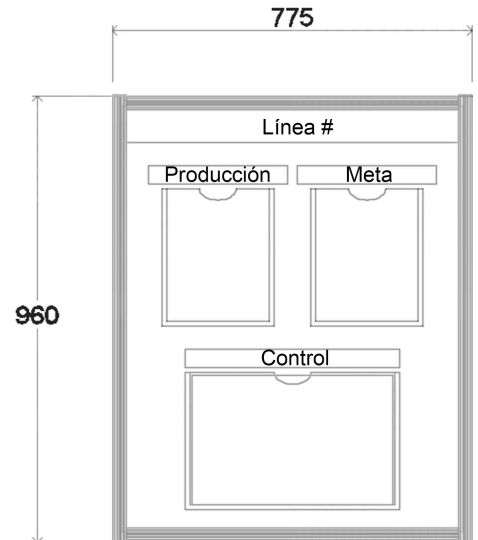

### 100-310-003

Panel melaminico blanco empotrable.

Incluye:

3 Acrílicos verticales con encabezado.

2 Acrílicos doble carta con encabezado.

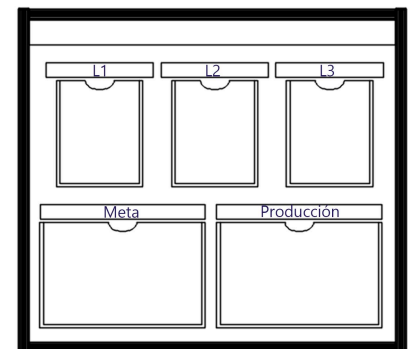
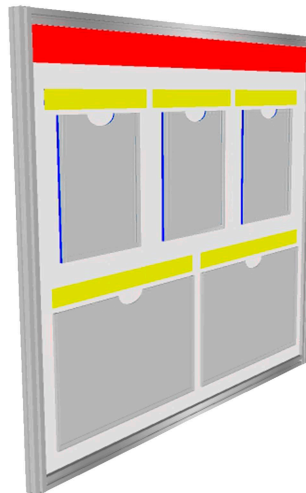

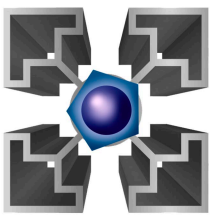

# PIZARRONES Y PÁNELES MÚLTIPLES

**Production Tools**

## 100-310-004

Panel melamínico blanco empotrable.

Incluye:  
9 Acrílicos verticales con encabezado

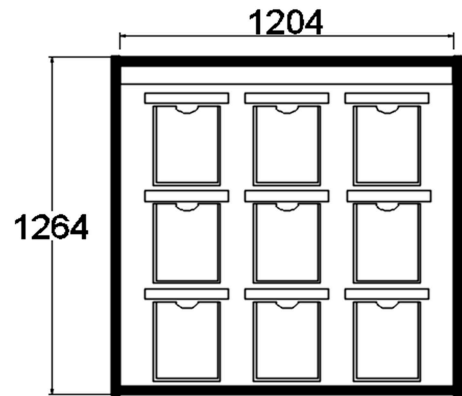

## 100-310-005

Pizarrón dual con corcho.

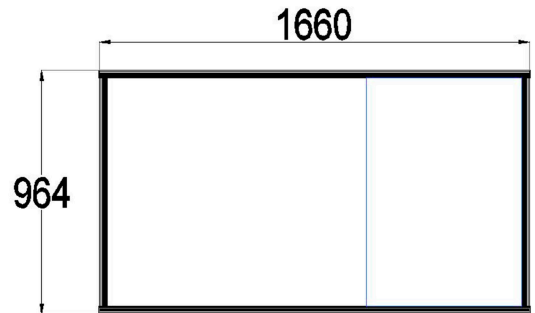
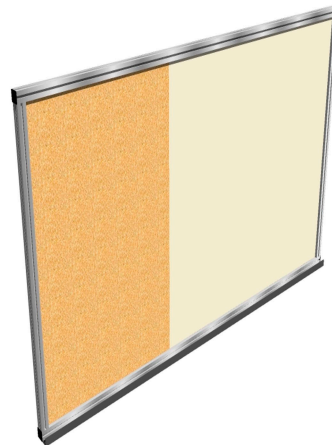

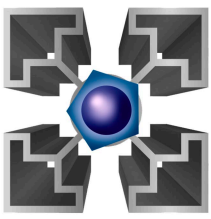

**Production Tools**

**100-320-001**

Panel melamínico blanco móvil.  
 Incluye:  
 2 Acrílicos verticales con encabezado  
 1 Acrílicos doble carta con encabezado

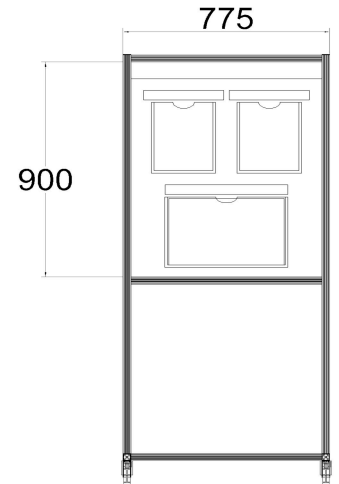
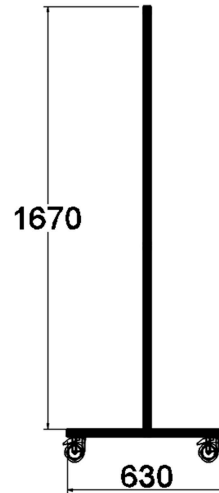
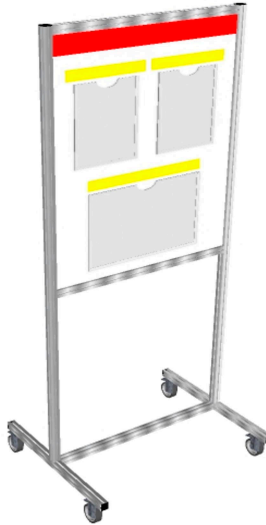

**100-320-002**

Panel melamínico blanco móvil.  
 Incluye:  
 9 Acrílicos verticales con encabezado.

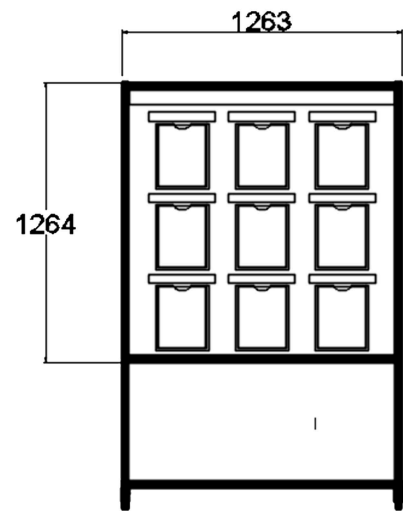
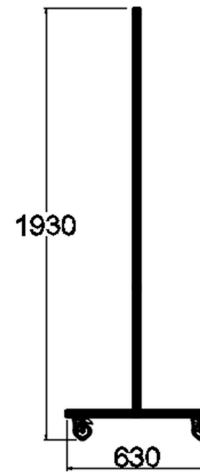

**100-320-003**

Panel melamínico blanco móvil.  
 Incluye:  
 9 Acrílicos verticales con encabezado.

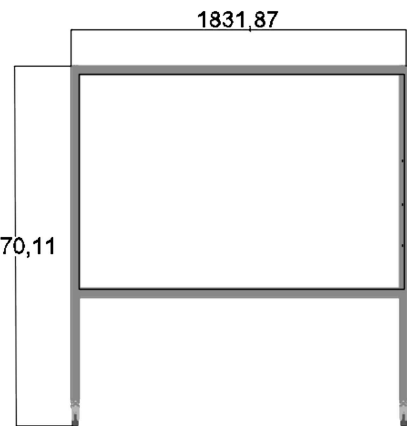
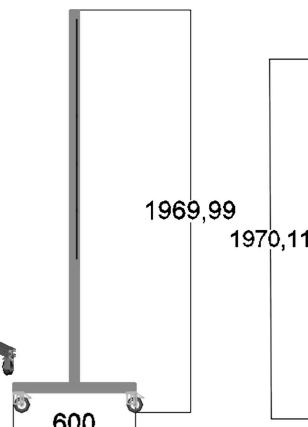
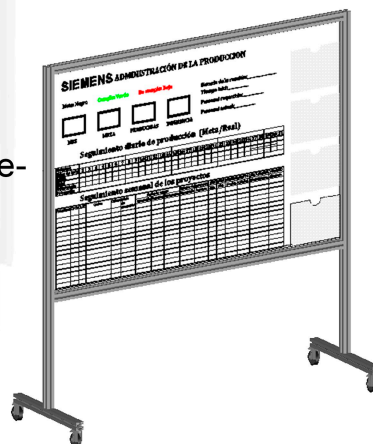

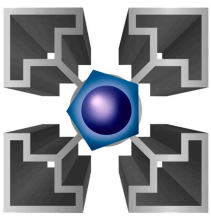

## Production Tools

### 100-410-001

Anaqueles de tres niveles sin puertas.

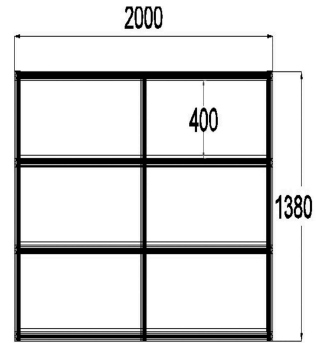
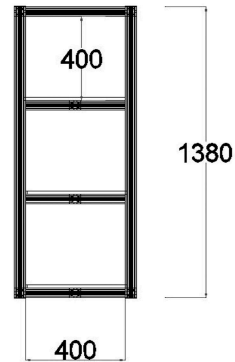
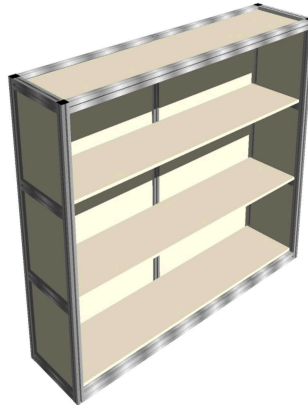

### 100-410-002

Anaqueles de cinco niveles con dos puertas corredizas de acrílico.

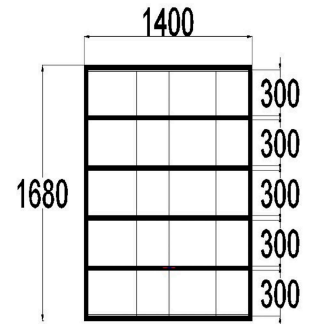
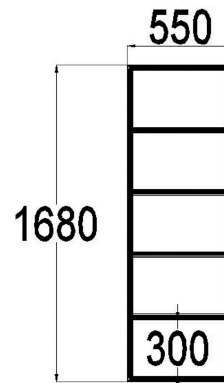
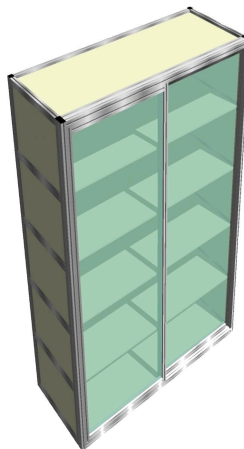

### 100-410-003

Anaqueles de cinco niveles con cinco puertas corredizas de acrílico.

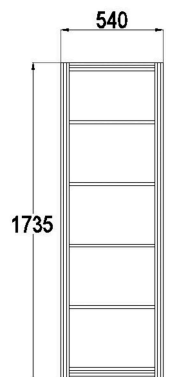
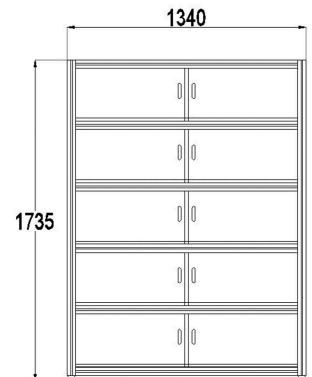

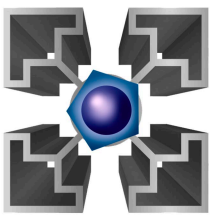

# RACKS

## Production Tools

### 100-410-004

Anaqueles con cinco niveles y separadores de mdf con cubiertas de neopreno.

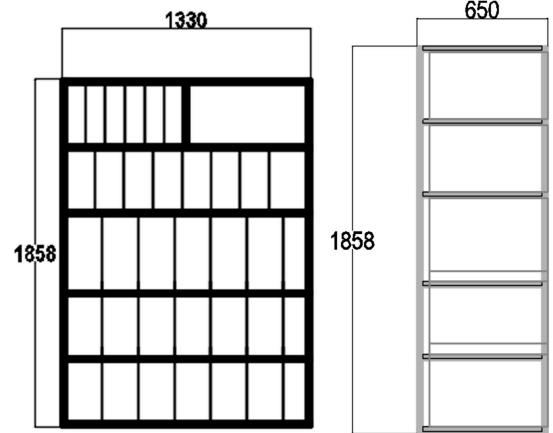
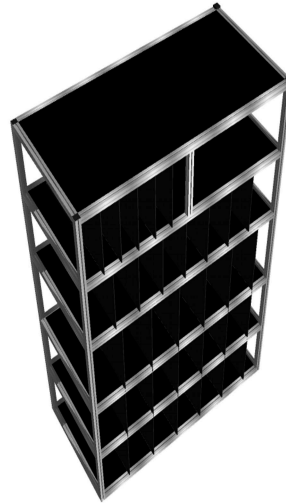

### 100-410-005

Anaqueles con cuatro niveles con cubiertas de neopreno.

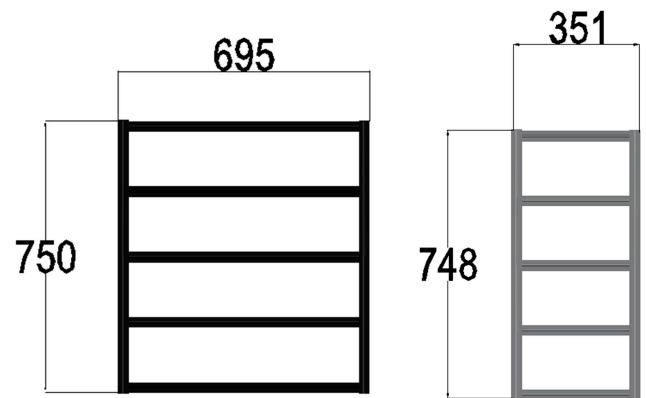
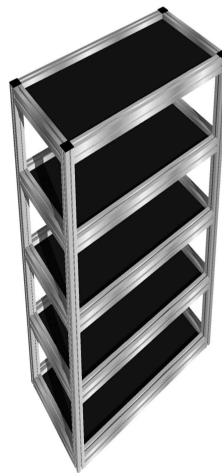

### 100-410-006

Anaqueles de almacenamiento con divisiones varias.

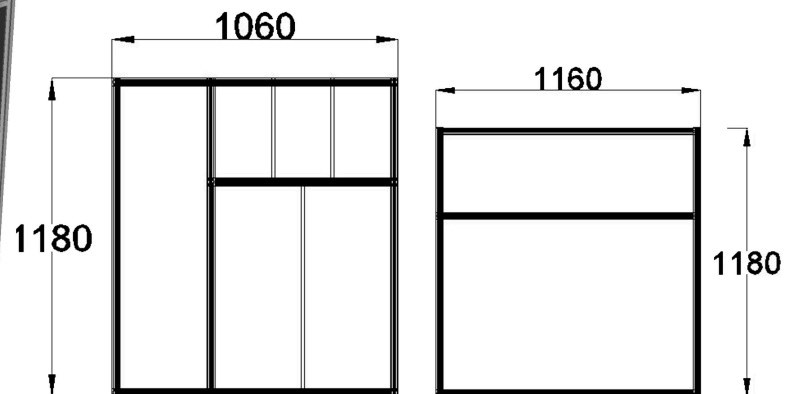
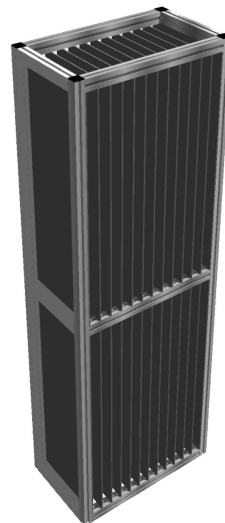



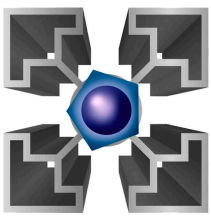

## Production Tools

### 100-410-007

Anaqueel de seis niveles con cuatro divisiones, cubiertas de foamy.

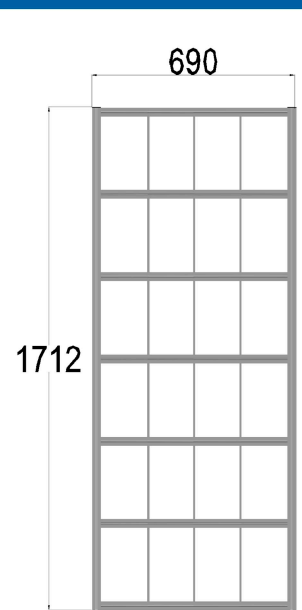
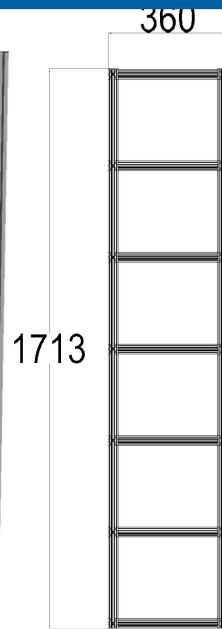
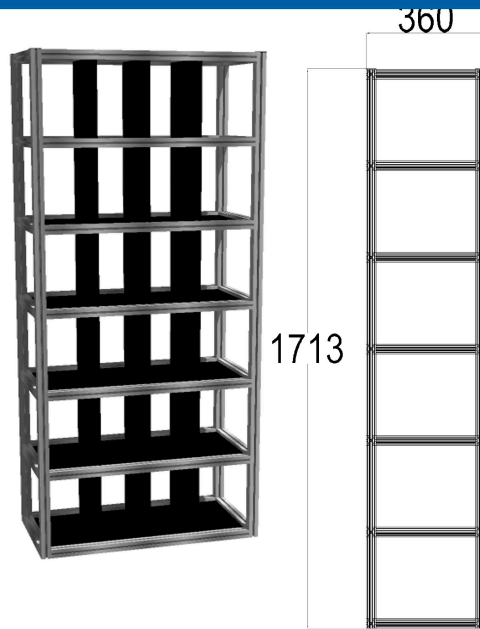

### 100-410-008

Anaqueel para empotrar de 3 divisiones con puerta de acrílico.

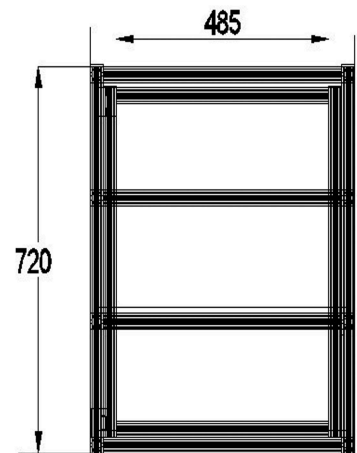
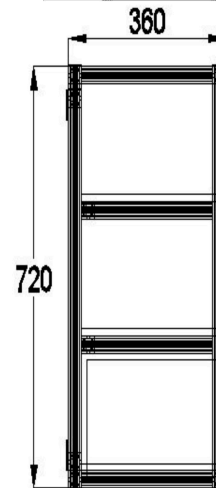

### 100-410-009

Anaqueel para empotrar de 3 divisiones con dos puerta de acrílico.

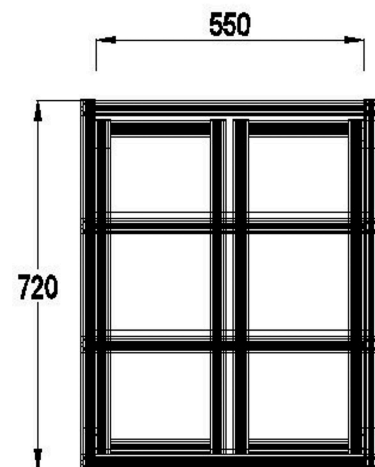
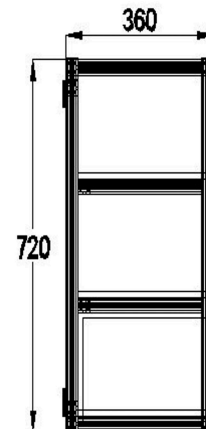

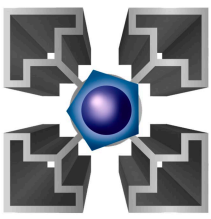

# RACKS

## Production Tools

### 100-420-001

Rack de 4 niveles, entrepaños ajustables.

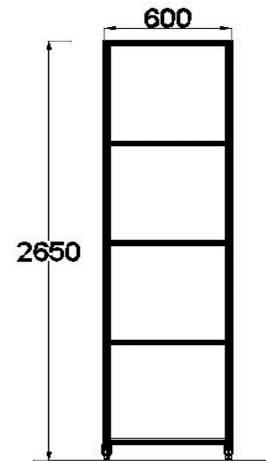
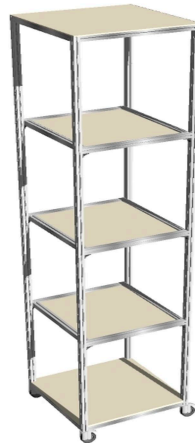

### 100-420-002

Rack de 4 niveles con puerta de acrílico.

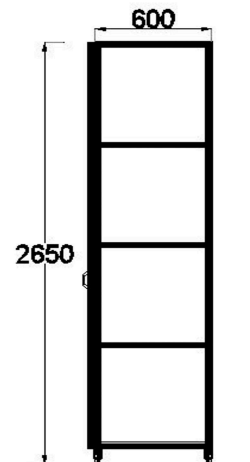
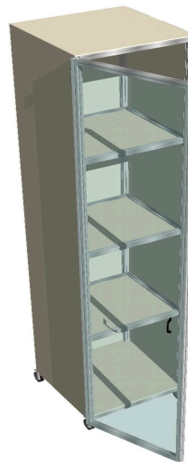

### 100-420-003

Rack de 5 niveles con puerta de acrílico.

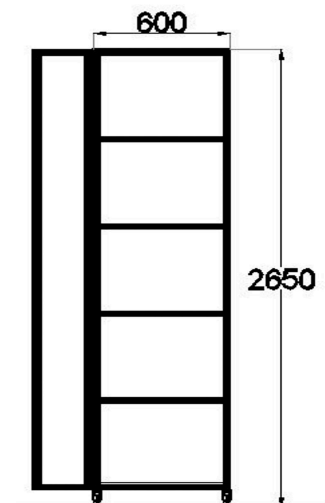
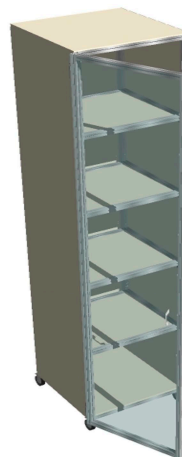

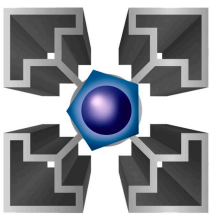

## Production Tools

### 100-420-004

Anaqueel de ocho niveles móviles en rejilla metálica con cubierta de acrílico.

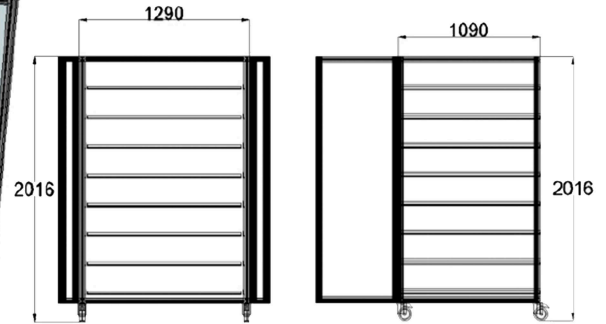

### 100-420-005

Rack de almacenamiento 4 divisiones en lamina de acero cubierta de neopreno, paredes en acrílico.

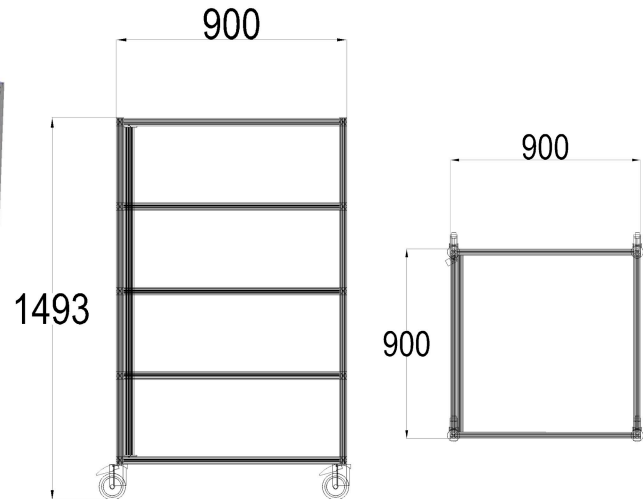

### 100-420-006

Rack transporte de carga con tubos.

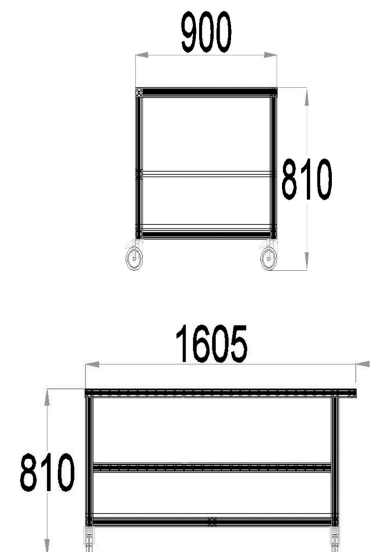

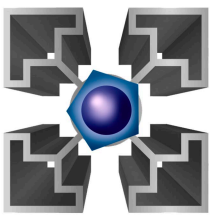

# RACKS

## Production Tools

### 100-420-007

Rack transporte de carga con tres niveles en lamina cal 10.

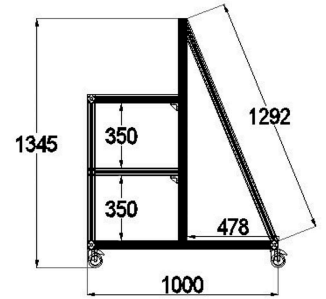
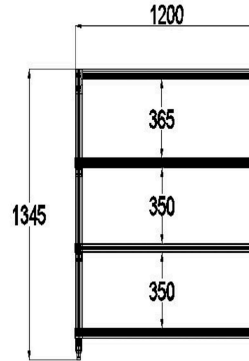
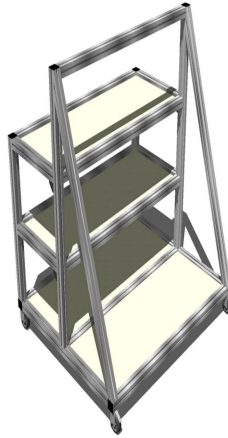

### 100-420-008

Rack transporte de carga con dos niveles de tubos separadores.

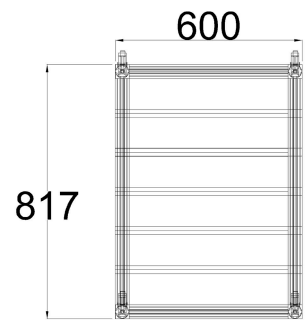
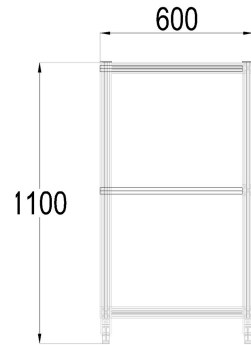
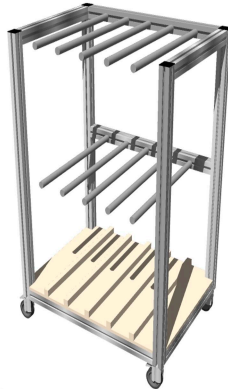

### 100-420-009

Rack transporte de carga con tubos separadores.

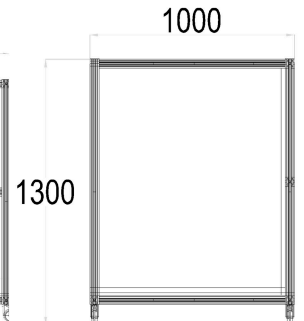
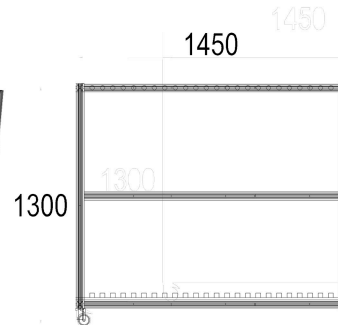

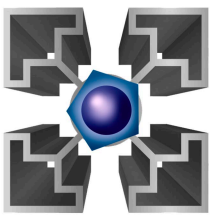

## Production Tools

### 100-420-010

Rack transporte de carga con dos bases y tubos separadores.

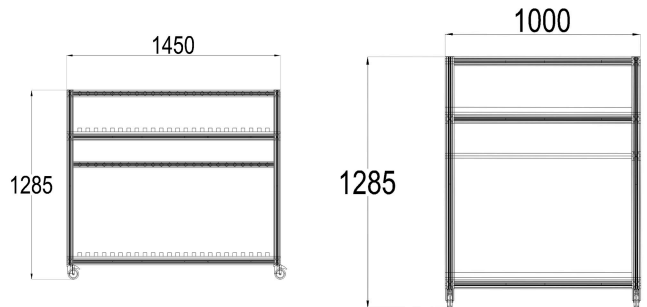

### 100-420-011

Rack para laminados de 5 niveles con rodillos.

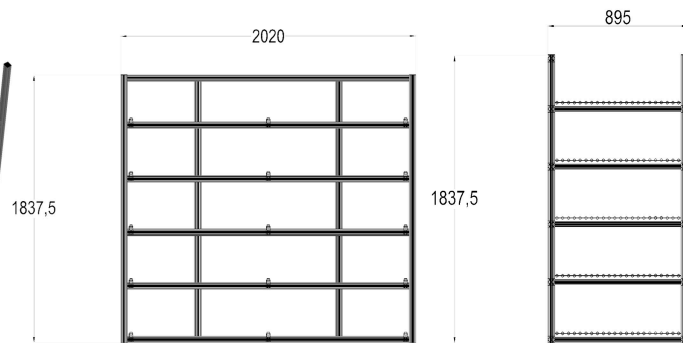

### 100-420-012

Rack para transporte con 6 divisiones en lámina galvanizada.

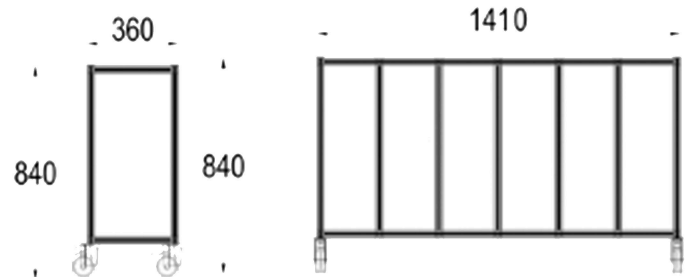

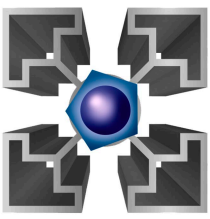

## RACKS

### Production Tools

**100-420-013**

Carro para almacenamiento de cables.

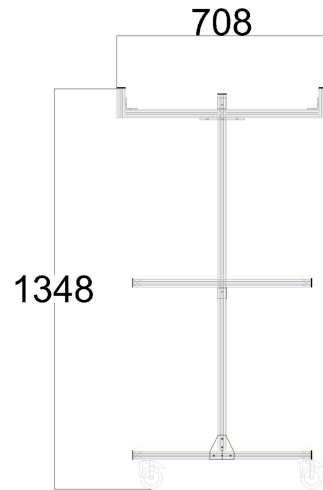

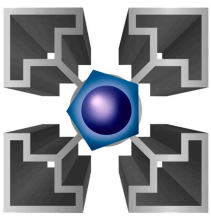

## Production Tools

### 100-510-001

Carro con 3 separadores y entrepaño cubierto en hule y parte superior con melamina.

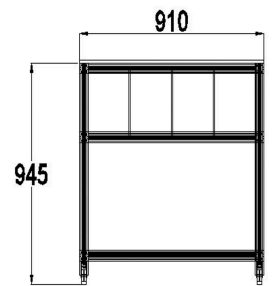
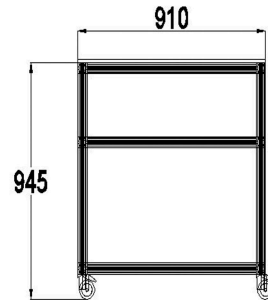

### 100-510-002

Carro para laminados con 5 separadores, un entrepaño.

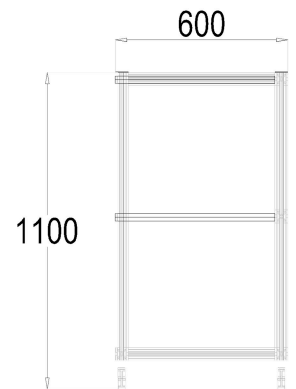
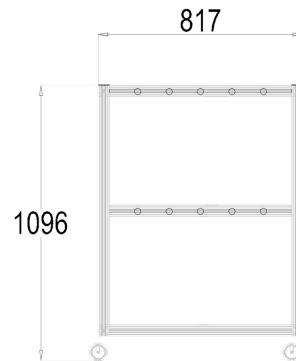

### 100-510-003

Carro para laminados con 5 separadores, un entrepaño con tres divisiones.

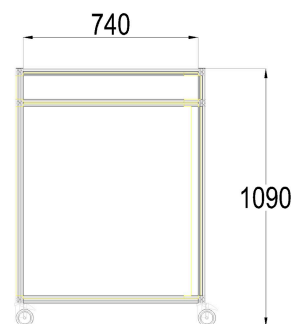
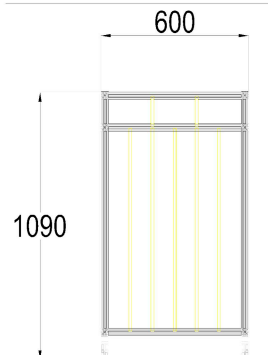

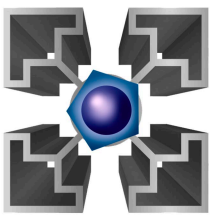

# CARROS

## Production Tools

### 100-511-001

Carro con charola de lámina con capacidad de carga de 200 kg.

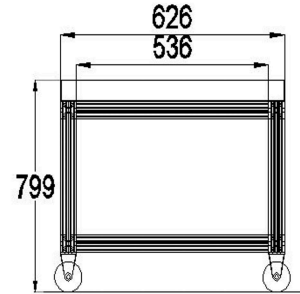
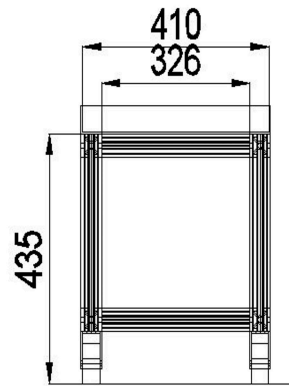

### 100-511-002

Carro con charola de lámina con capacidad de carga de 300 kg

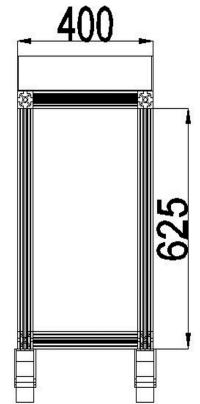
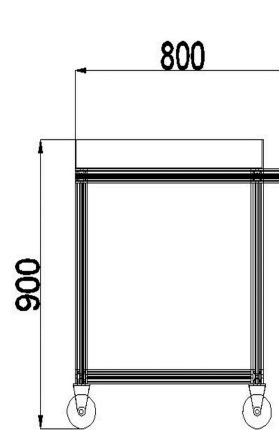

### 100-511-003

Carro con charola con capacidad de carga de 200 kg, con melamina en nivel inferior.m

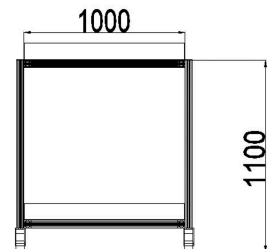
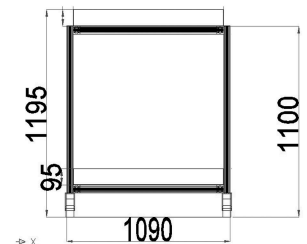
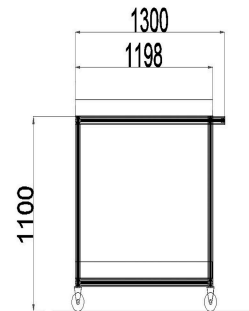



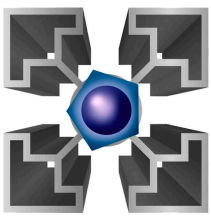

Production Tools

**100-520-001**

Carro móvil de dos niveles para manejo de materiales.

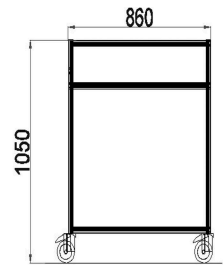
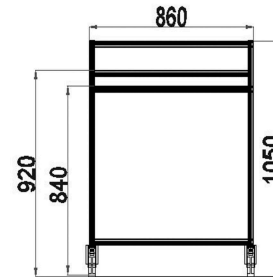

**100-520-002**

Carro móvil de una repisa de posición ajustable.

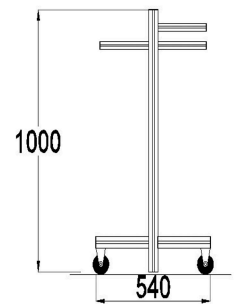
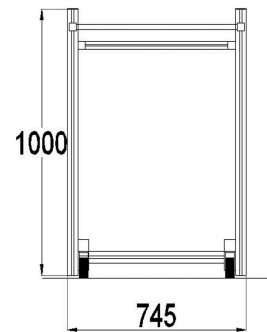

**100-520-003**

Carro móvil de dos repisas de posición ajustable.

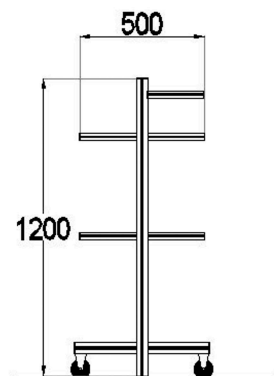
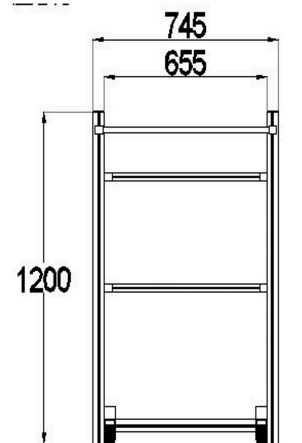
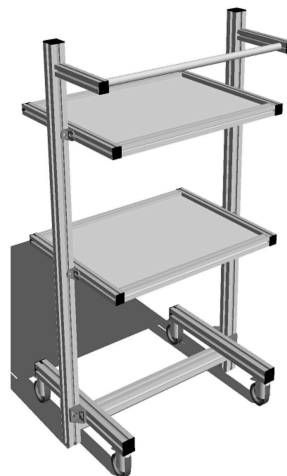

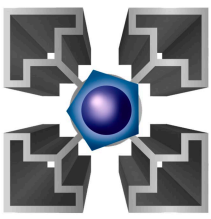

# CARROS

## Production Tools

### 100-520-004

Carro de tres repisas de posición ajustable.

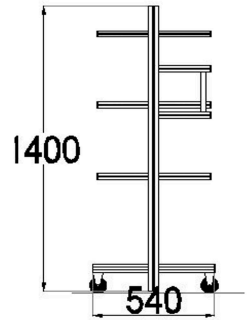
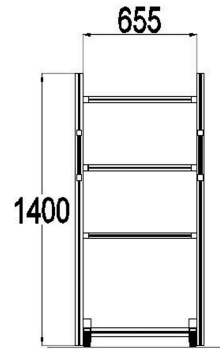
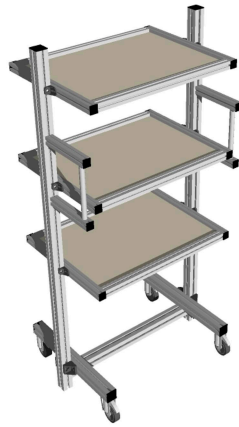

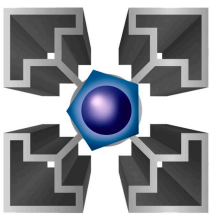

## Production Tools

### 100-530-001

Carro para inventario con caja deposición ajustable cerrada en acrílico y panel con 4 porta hojas.

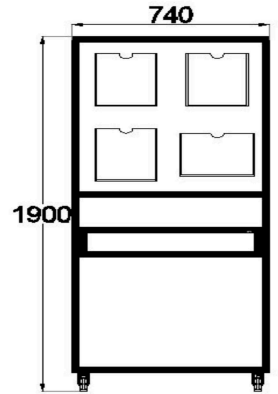
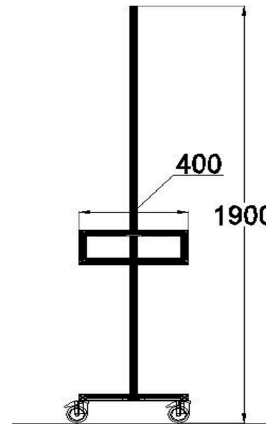
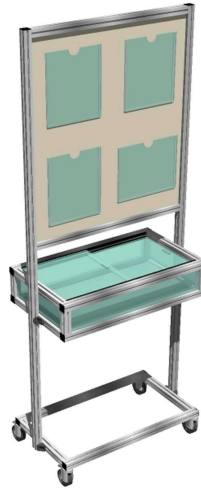

### 100-530-002

Carro para disposición de materiales cuatro niveles, panel con dos porta hojas de acrílico.

Incluye:

22 gavetas de 17 x 10.5 x 7.6 cm

8 gavetas de 18.5 x 11.8 x 7.6 cm

6 gavetas de 27.6 x 16.2 x 12.5 cm

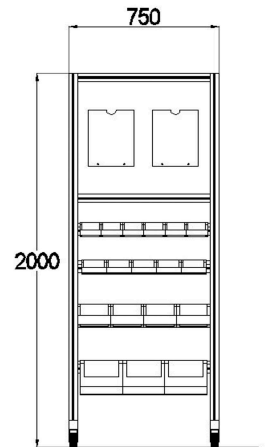
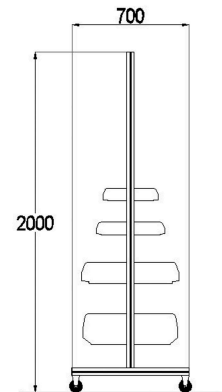
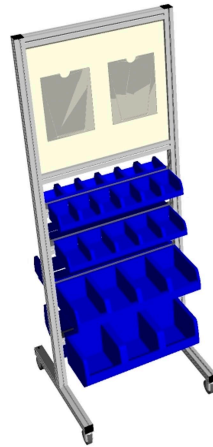

### 100-530-003

Carro para inventario con 2 niveles y ruedas .

Incluye :

2 charolas

Gavetas plásticas

Repisas de posición y ajustables.

Panel sencillo en perfil.

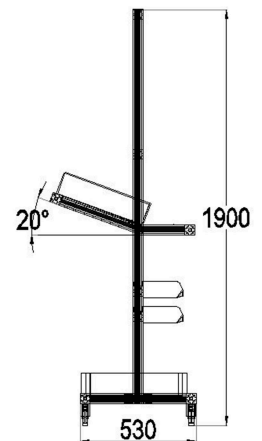
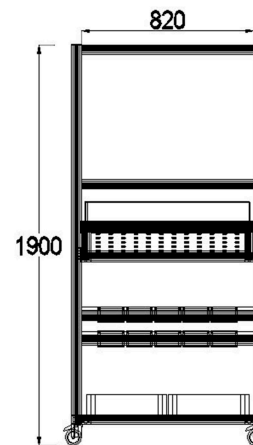
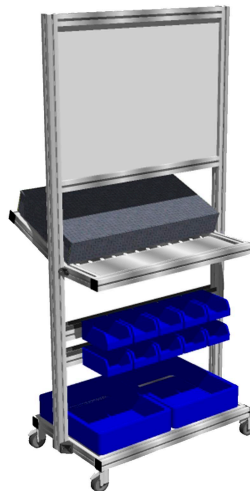

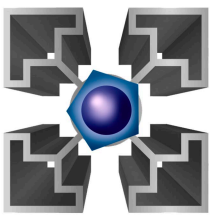

# CARROS

## Production Tools

### 100-530-004

Carro para inventario con cajón y baúl paredes en acrílico y panel con 4 porta hojas.

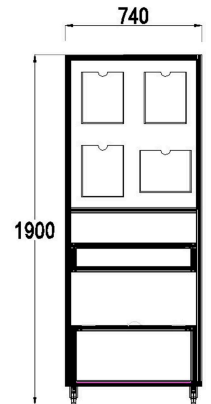
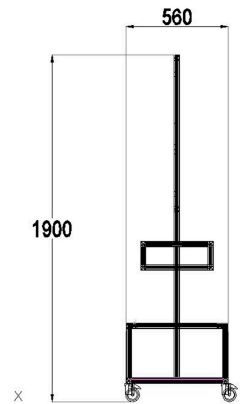
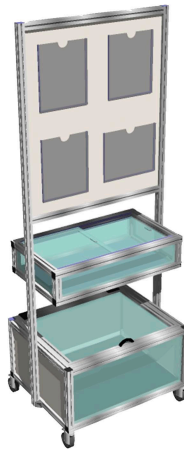

### 100-530-005

Carro para inventario con cajón y baúl en lámina, panel con 4 porta hojas.

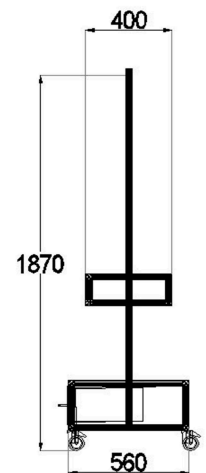
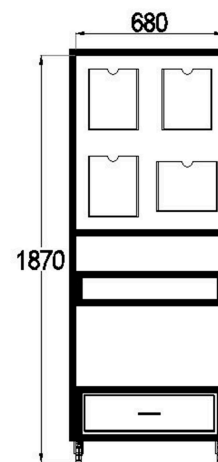
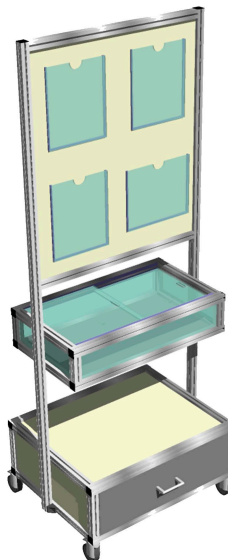

### 100-530-006

Carro con 2 cajoneras metálicas, repisa, bastidor con ganchos y 5 canales para gavetas.

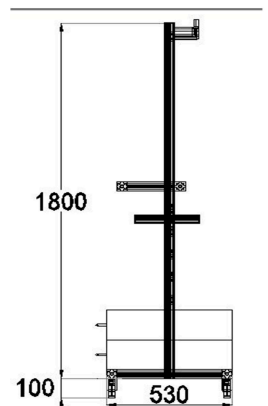
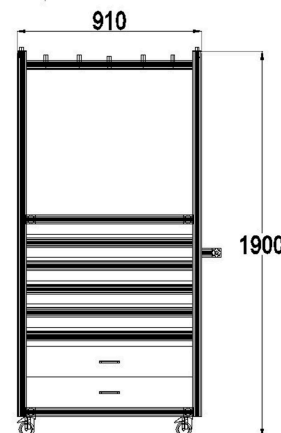
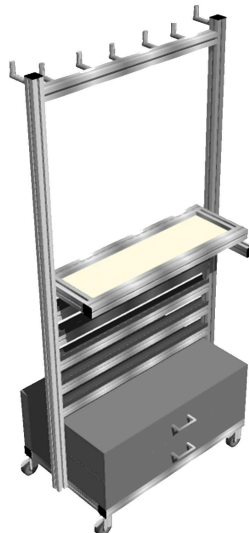

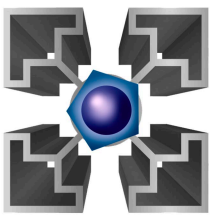

## Production Tools

### 100-530-007

Carro con 2 cajoneras metálicas, repisa, bastidor con ganchos y 2 canaletas para gavetas.

Incluye:

10 gavetas de 17 x 10.5 x 7.6 cm  
2 tinas de 48.0 x 38 x 10.4

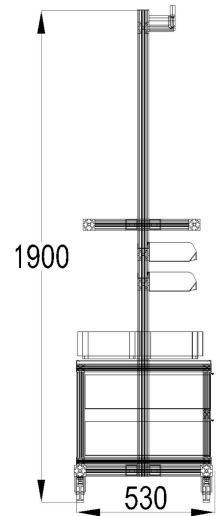
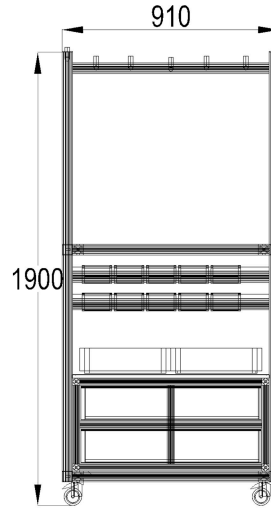

### 100-530-008

Carro para disposición de materiales.

Incluye:

10 gavetas de 17 x 10.5 x 7.6 cm  
3 tinas de 38.0 x 24.0 x 10.4

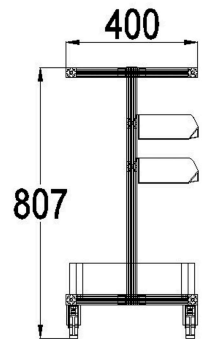
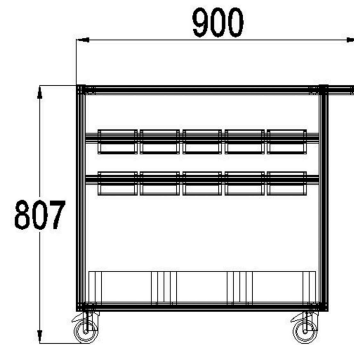
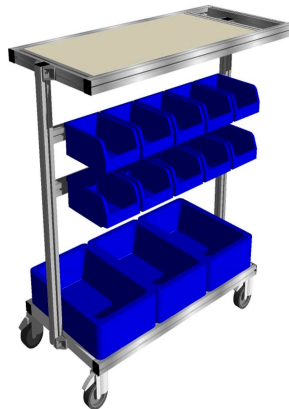

### 100-530-009

Carro para herramientas con dos cajones metálicos.

incluye:

10 gavetas de 17 x 10.5 x 7.6 cm

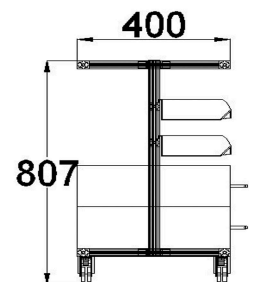
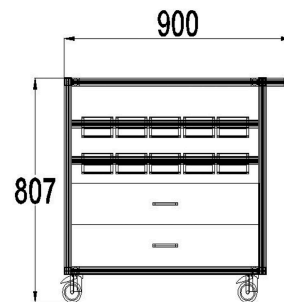
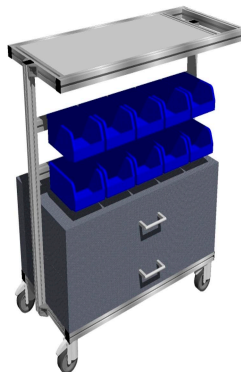

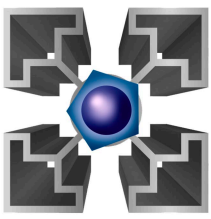

## Production Tools

### 100-610-001

Transportador con rodillos a piso de carga ligera, secciones de 2m de longitud

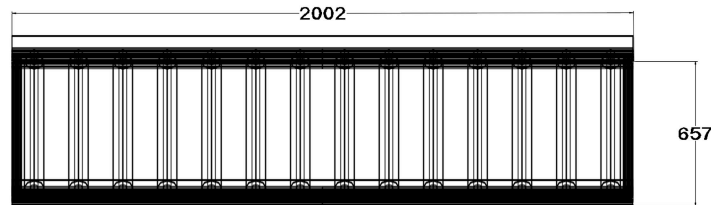

### 100-610-002

Transportador con rodillos a piso, carga ligera, secciones de 3m de longitud.

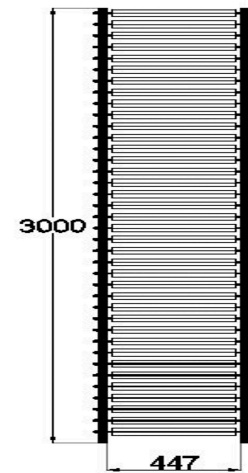

### 100-610-003

Transportador con bastidor de altura ajustable.

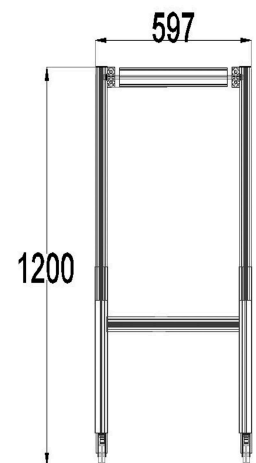
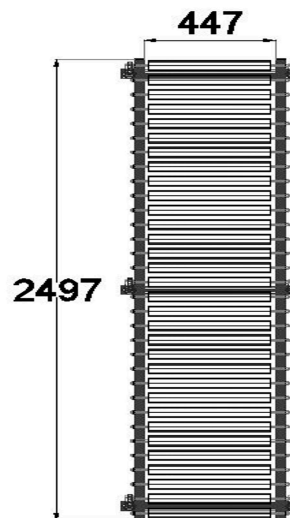

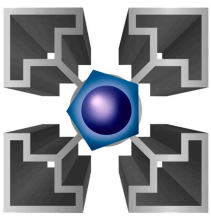

## Production Tools

### 100-610-004

Transportador de 1 m con bastidor metálico empotrable a piso

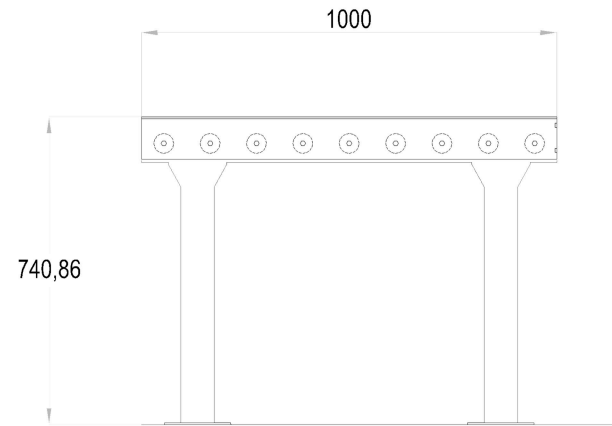
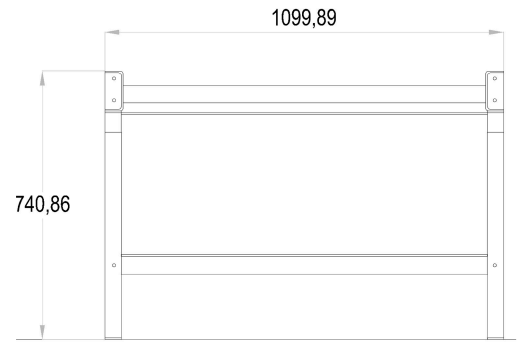

### 100-610-005

Transportador de 1.9 m con bastidor metálico

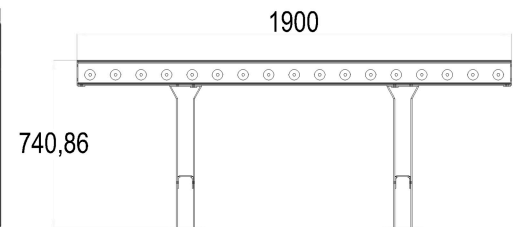
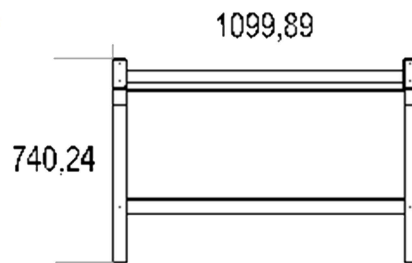
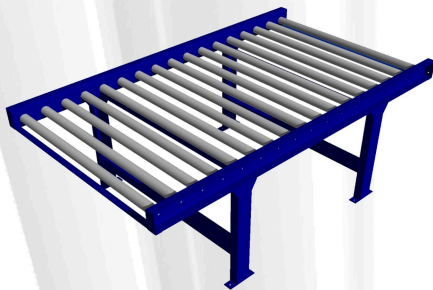

### 100-610-006

Transportador con rodillos curvos.

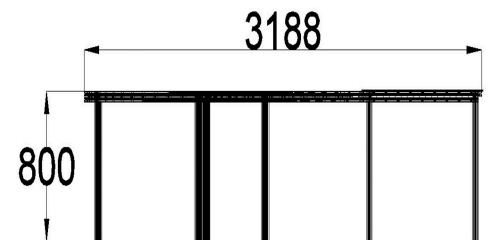
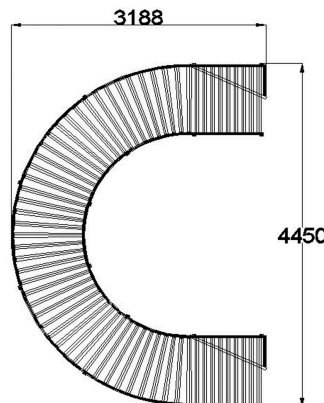
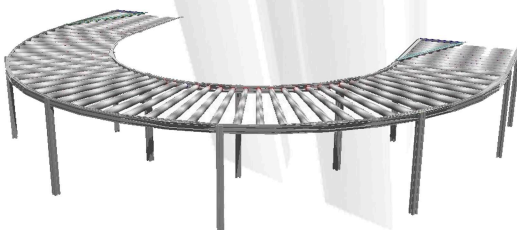

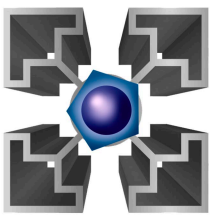

## Production Tools

### 100-611-001

Base de transporte pesado con capacidad de carga 1000 kg.

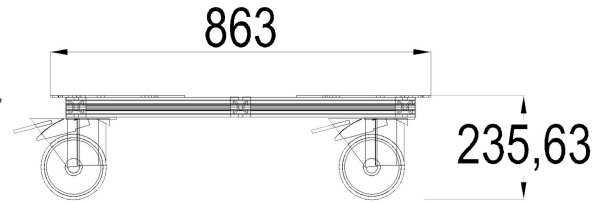
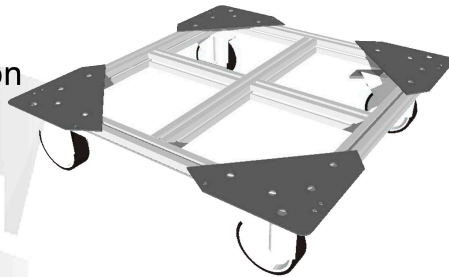

### 100-620-001

Bastidor móvil con travesaños ajustables y bandeja de metal.

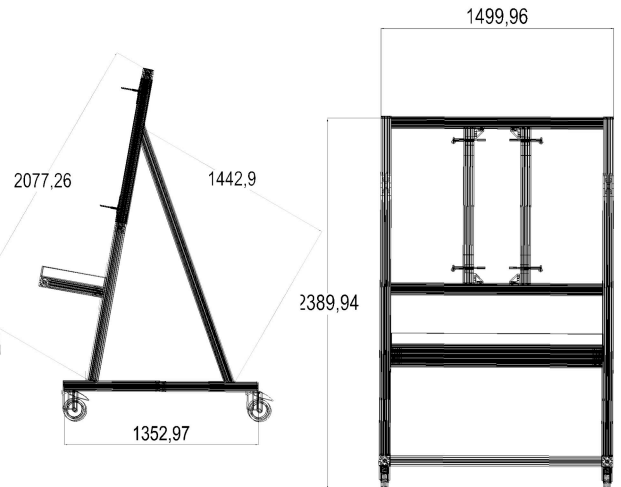

### 100-620-002

Dispositivo portatinas una entrada una salida, accionamiento manual.

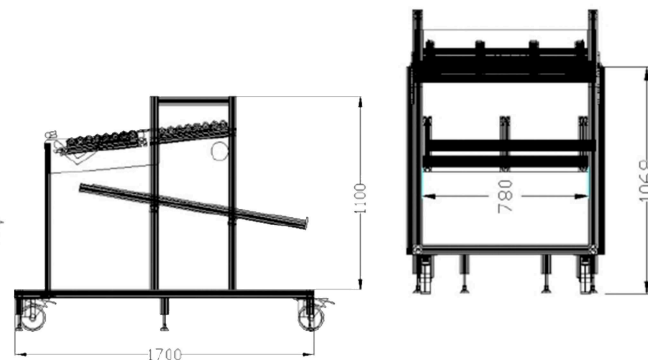
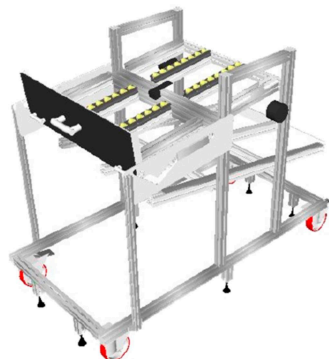



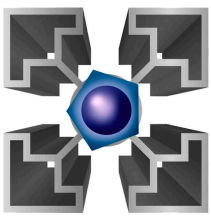

## Production Tools

### 100-630-001

Dispositivo de elevación ajustable por medio de pedal accionamiento hidráulico.

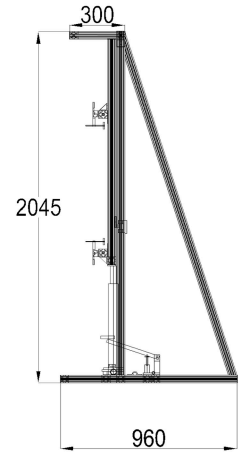
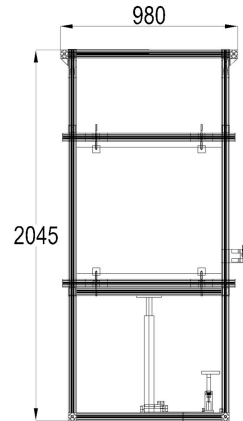

### 100-630-002

Dispositivo de elevación ajustable, accionamiento neumático.

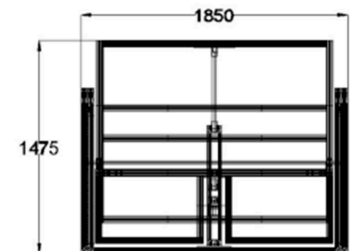
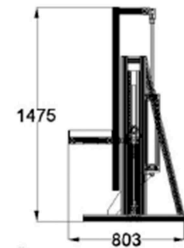

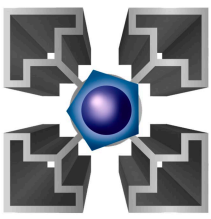

## Production Tools

### 100-710-001

Escalera móvil con 2 peldaños charola, pasamanos.

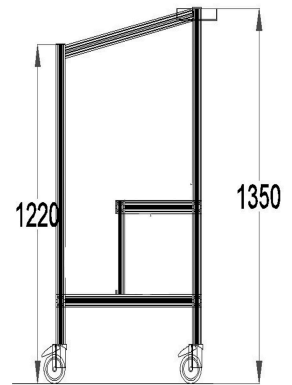
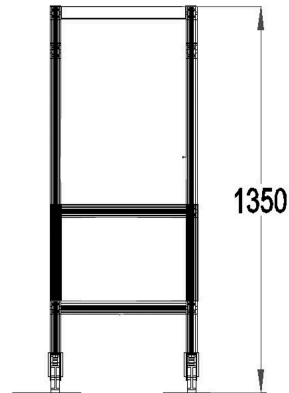
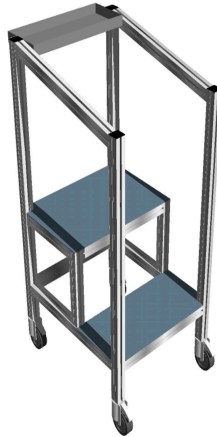

### 100-710-002

Escalera móvil con 3 peldaños y descanso, pasamanos.

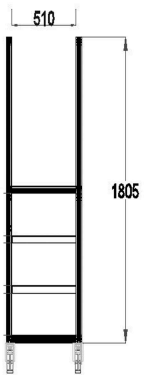
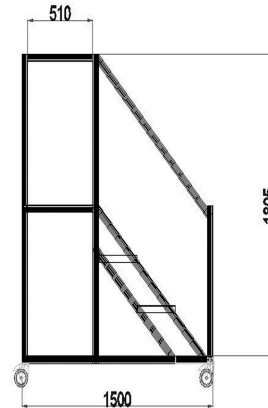

### 100-710-003

Escalera móvil con 3 peldaños charola, pasamanos.

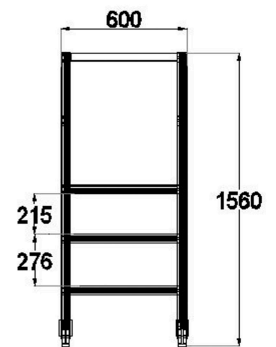
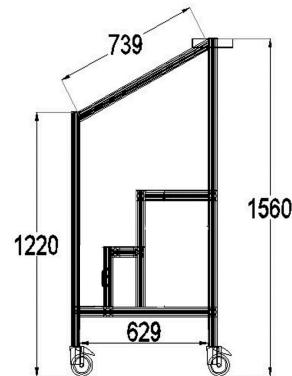
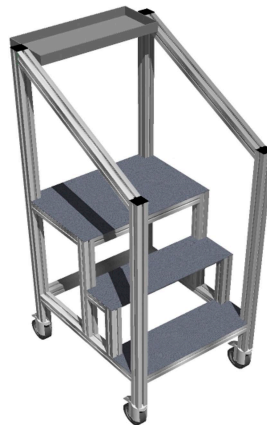

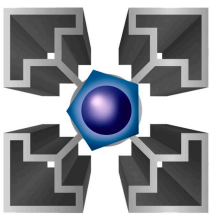

## Production Tools

### 100-710-004

Escalera móvil con 4 peldaños charola, pasamanos.

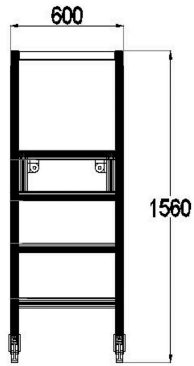
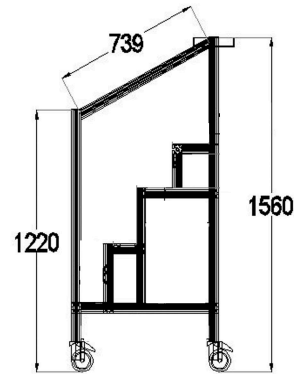
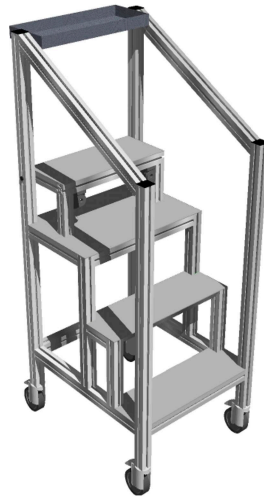

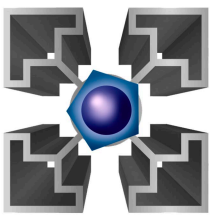

## Production Tools

### 100-720-001

Plataforma desmontable con dos secciones de escacleras, sin pasamanos.

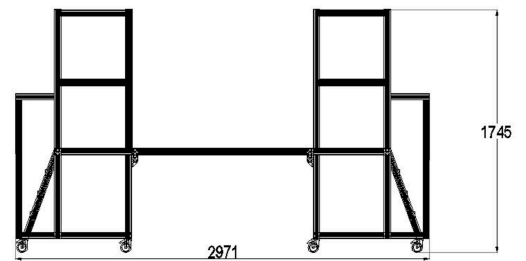
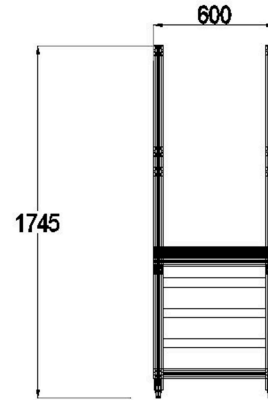

### 100-720-002

Plataforma de 4 peldaños con pasillo desmontable, con pasamanos.



### 100-720-003

Plataforma de 7 peldaños con pasillo desmontable y pasamanos.

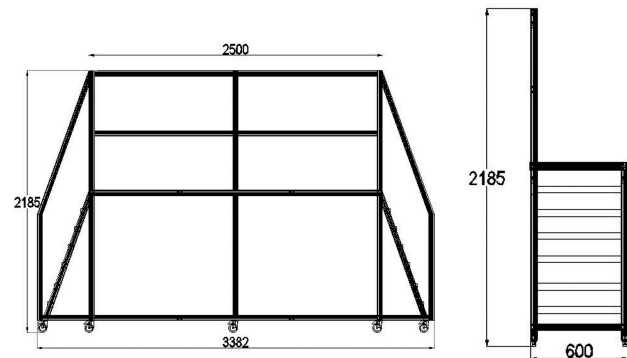

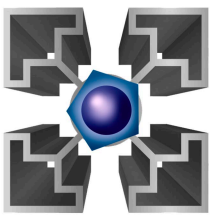

## Production Tools

### 100-810-001

Sistema de protección o guarda horizontal con malla ondulada galvanizada.

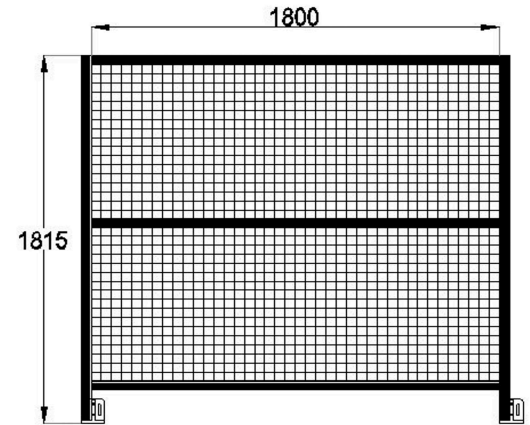
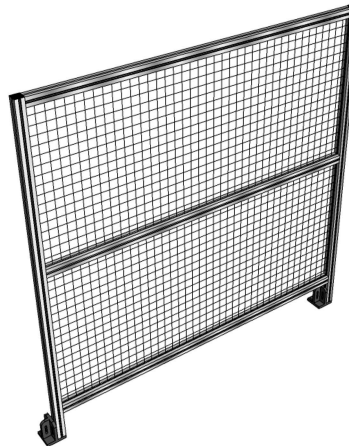

### 100-810-002

Sistema de protección o guarda vertical con malla ondulada galvanizada.

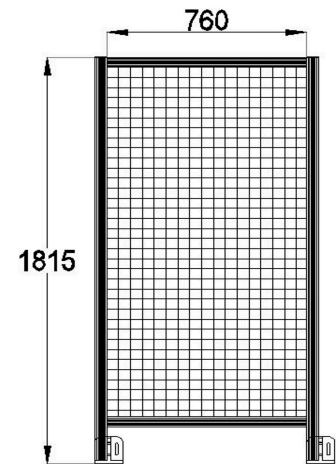
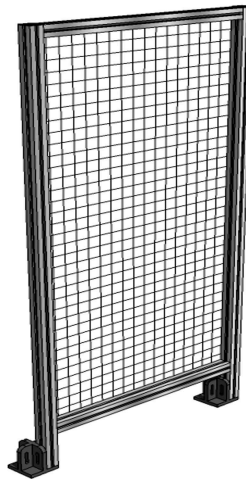

### 100-801-003

Puerta para sistema de protección o guarda con manija y chapa de seguridad en malla ondulada.

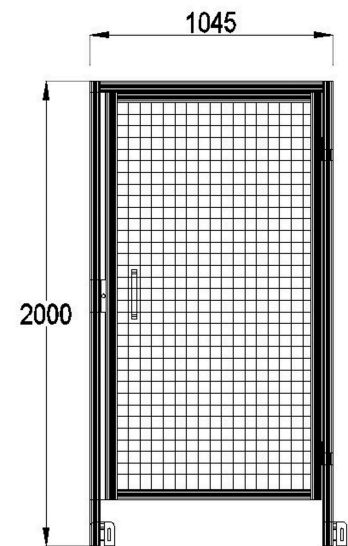
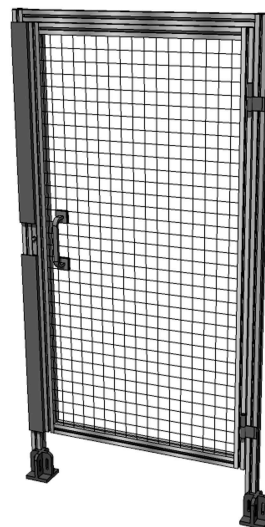

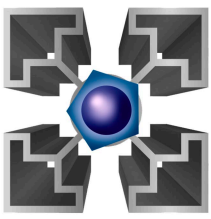

## Production Tools

### 100-910-001

Cabina de mdf y cristal armado con bastidor.  
(Sobre diseño)

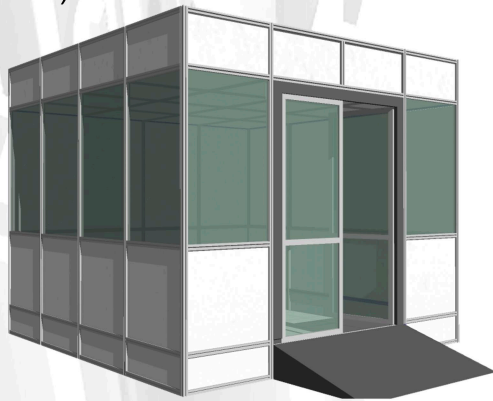

### 100-920-002

Cabina de inspección con paredes de melamina blanca.

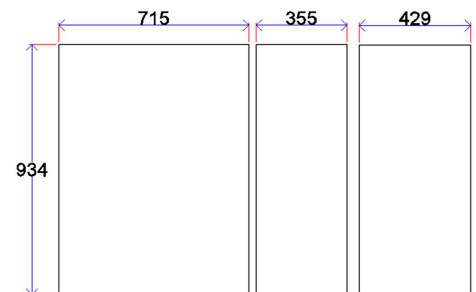
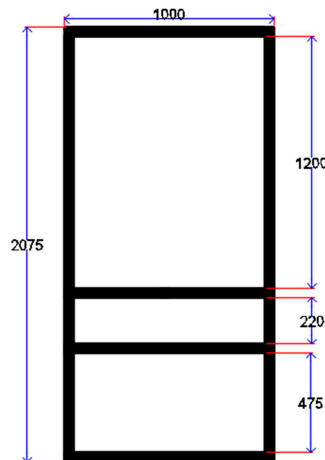
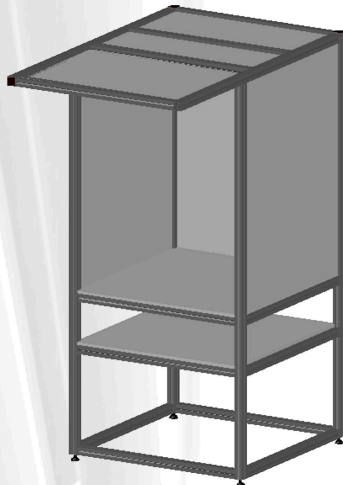

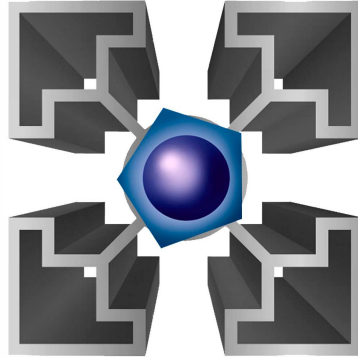

## **Production Tools**

**[www.productiontools.com.mx](http://www.productiontools.com.mx)**

**E-mail: [ventas@ptools.com.mx](mailto:ventas@ptools.com.mx)**

**TELS: 55 63 76 00 / 53 63 09 94**

**AV. PRESIDENTE ADOLFO LOPEZ MATEOS NUM 8  
COL. EX HACIENDA DEL PEDREGAL  
ATIZAPÁN DE ZARAGOZA, EDO. DE MÉXICO  
C.P. 052966**